

New

Pressure Switch/Reed Switch Type

16% lighter

Weight: 62 g

*Previous type 74 g
Compared with IS1000
(Made by SMC)

11% smaller

Overall height: 52 mm

*Previous type 58.5 mm
Compared with IS1000
(Made by SMC)

- 100 V AC/DC specifications
- Set pressure range **0.1 to 0.4 MPa**
- Service life: **5 million cycles**



RoHS



- Can be connected to Modular type F.R.L. units.

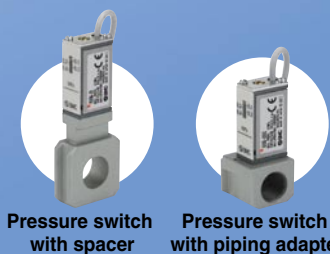
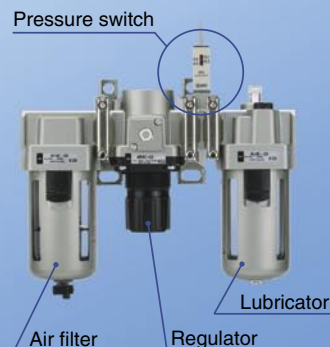

Specifications

Model	IS10-01
Fluid	Air/Inert gas
Proof pressure	1.0 MPa
Max. operating pressure	0.7 MPa
Set pressure range	0.1 to 0.4 MPa Option: 0.1 to 0.6 MPa
Ambient and fluid temperature	-5 to 60°C (No freezing)
Contacts	1a
Error of scale	±0.05 MPa or less
Hysteresis	Fixed 0.08 MPa or less
Repeatability	±0.05 MPa or less
Wiring specifications	Grommet, Lead wire length: 0.5 m Option: 3 m, 5 m
Enclosure	Equivalent to IP40
Port size	1/8
Weight	62 g

Switch Characteristics

Max. contact capacity	AC 2 A, DC 2 W		
	24 V or less	48 V	100 V
Max. operating current and range	50 mA	40 mA	20 mA

Electrical Circuit

Up to 100 V AC/DC

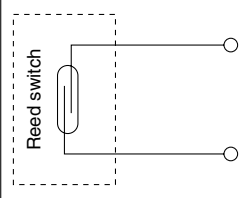

JIS Symbol

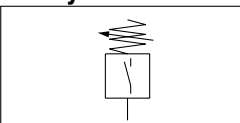

Set Pressure Range

----- ON pressure — OFF pressure

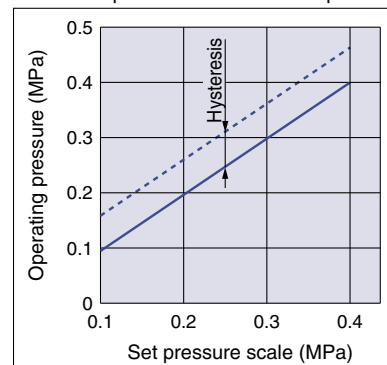

How to Order

IS10-**1**01**2**-**3**

	Symbol	Description		
①	Thread type	— Rc N NPT +		
	②	Seal	— None S With seal +	
		a	Set pressure range	— 0.1 to 0.4 MPa 6 Note1) 0.1 to 0.6 MPa +
b	Lead wire length		— 0.5 m L 3 m Z 5 m +	
			c	Scale plate pressure unit

Semi-standard: Select one option each in a through c. Place them in alphanumerical order.

Example) IS10-N01-6PZ

Note 1) Set pressure range of 6P(L, Z) is 0.2 to 0.6 MPa (30 to 90 psi).

Note 2) This product is for overseas use only according to the new Measurement Law. (The SI unit type is provided for use in Japan.)

Series **IS10**



CAT.EUS60-19A-UK

Series IS10

Dimensions/Construction

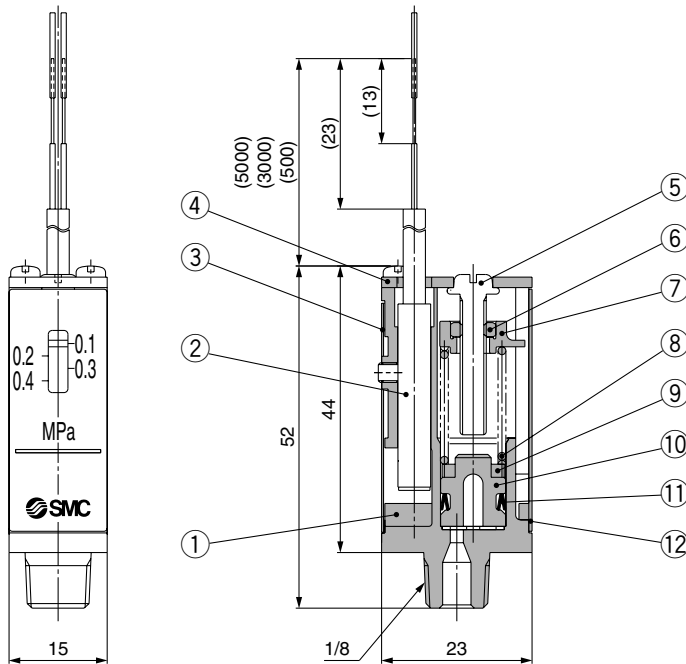

Component Parts

No.	Description	Material
1	Body	ZDC
2	Switch assembly	—
3	Shield plate	Steel sheet
4	Cover	Steel sheet
5	Adjusting screw	Brass
6	Hexagon nut	Brass
7	Indicator	PBT
8	Spring	Stainless steel
9	Magnet	—
10	Piston	POM
11	Seal piston	NBR
12	Scale plate	PC

Wiring

⚠ Warning

1. **Connect load before connecting with power source.**
The switch will break instantly if no load is connected.
2. **Make the wiring length as short as possible. When the load which is operated by the pressure switch is an inductive load, or the lead wire is 5 m or longer, use the contact protection box shown in the table below.**
Otherwise, damage to the switch can result.

Part no.	Voltage	Lead wire length
CD-P11	100 V AC	Switch side: 0.5 m Load side: 0.5 m
CD-P12	24 V DC	Load side: 0.5 m

• Internal circuit of contact protection box

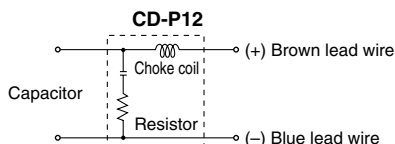
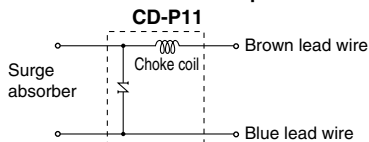

- **How to connect contact protection box**
Connect the lead wires from the body and the contact protective box side indicated "SWITCH." Make the lead wire as short as possible, within 1 m.

3. Dimensions of lead wire

Enclosure: ϕ 3.4
Insulator: ϕ 1.1
Conductor: ϕ 0.64

For details, refer to the operation manual.

Mounting

⚠ Warning

1. When handling the product, hold the body and do not apply tensile stress to the power supply cable. Otherwise, damage may occur to the product.
2. **Avoid repeatedly bending or stretching the lead wire.**
Wiring which applies repeated bending and tensile stress to the lead wire can break the circuit. If the lead wire is damaged, causing operation failure, replace the product with a new one.
3. **Do not drop or bump the product when handling the product.**
4. **Apply a wrench to the bottom of the product when screwing.**
Turning it by applying a wrench on the top of the main body may cause damage to the product. Recommended tightening torque: 7 to 9 N·m

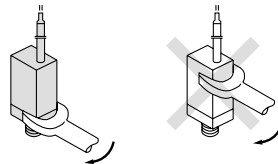

5. **Mounting direction is available in either horizontal or perpendicular.**

Operating Environment

⚠ Warning

1. **Avoid using a switch in a magnetic environment.**
It may cause a malfunction.
2. **Do not use in such an environment, where water or oil is splashed.**
Since it is the open type construction, if water or oil make an ingress into the internal parts, the electric circuit will be corroded and may result in a malfunction or damage.
3. **Avoid vibration.**
Vibration may cause a malfunction or may cause setting to be incorrect.

Pressure Source

⚠ Warning

1. **Operating fluids are either air or inert gas exclusively.**
Never use other fluids. Never use in an environment where flammable fluid or gas is used. Since this is not an explosion-proof construction, it may lead to an explosive disaster.
2. **Not applicable to corrosive gas and liquid.**
Otherwise, damage to the body or liquid leakage can result.
3. **Avoid use in vacuum applications.**
Switch may be imploded.
4. **This product (Series IS10) uses a reed switch. If the chattering of the output signal is a problem, choose a solid state type pressure switch or adjust by PLC.**

Pressure Setting

⚠ Warning

1. **Set within the display pressure range of the scale plate.**

⚠ Caution

1. **The pressure can be adjusted by rotating the adjustment screw. The red indicator goes up and down according to the adjustment.**
Rotate the screw clockwise for high pressure.
2. **Use a screwdriver of a size suitable for the groove of the adjustment screw.**
3. **Scale of switching set display is the set value at the pressure drop.**
4. **The ON signal is output through the pressure set on the scale plate, to which the hysteresis is added for detecting the ON-pressure signal.**
5. **The pressure displayed on the scale plate is a guideline only.**
Measure the accurate pressure with the pressure gauge.

Pressure Switch for Connecting to Modular/F.R.L. Units

Pressure Switch with Spacer

IS10M - 30 -

① ②

Semi-standard: Select one option each in a through c.
Place them in alphanumerical order.
Example) IS10M-6LP

		Symbol	Description	① Body size					
				20	30	40	50	60	
② Semi-standard	a	Set pressure range	—	0.1 to 0.4 MPa	●	●	●	●	●
			6 (Note 1)	0.1 to 0.6 MPa	●	●	●	●	●
	b	Lead wire length	+	—	0.5 m	●	●	●	●
			L	3 m	●	●	●	●	
			Z	5 m	●	●	●	●	
c	Scale plate pressure unit	—	MPa	●	●	●	●	●	
		P (Note 2)	Both MPa and psi	●	●	●	●	●	

Note 1) Set pressure range of 6P(L, Z) is 0.2 to 0.6 MPa (30 to 90 psi).
Note 2) This product is for overseas use only according to the new Measurement Law. (The SI unit type is provided for use in Japan.)

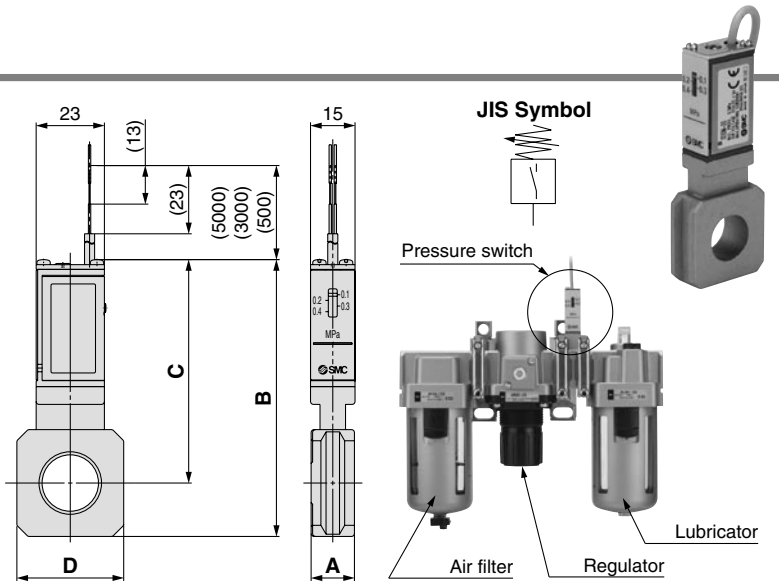

Model	A	B	C	D	Applicable model
IS10M-20	11	74	64	28	AC20□
IS10M-30	13	85	71	30	AC25□, AC30□
IS10M-40	15	93	75	36	AC40□
IS10M-50	17	97	77	44	AC40□-06
IS10M-60	22	91	67	53	AC50□, AC55□, AC60□

Note) Prepare a spacer separately for modular connection.

Pressure Switch with Piping Adapter

IS10E - 30 - -

① ② ③ ④

Semi-standard: Select one option each in a through d.
Place them in alphanumerical order.
Example) IS10E-30N03-6PRZ

		Symbol	Description	① Body size				
				20	30	40		
②	Thread type	—	Rc	●	●	●		
		N	NPT	●	●	●		
		F	G	●	●	●		
③	Port size	01	1/8	●	—	—		
		02	1/4	●	●	—		
		03	3/8	●	●	●		
		04	1/2	—	●	●		
		06	3/4	—	—	●		
④ Semi-standard	a	Set pressure range	—	0.1 to 0.4 MPa	●	●	●	
			6 (Note 2)	0.1 to 0.6 MPa	●	●	●	
	b	Lead wire length	+	—	0.5 m	●	●	●
				L	3 m	●	●	●
				Z	5 m	●	●	●
	c	Scale plate pressure unit	—	MPa	●	●	●	
			P (Note 1)	Both MPa and psi	●	●	●	
	d	Mounting position	—	Right	●	●	●	
R			Left	●	●	●		

Note 1) For thread type: NPT only.
This product is for overseas use only according to the new Measurement Law. (The SI unit type is provided for use in Japan.)
Note 2) Set pressure range of 6P(L, Z) is 0.2 to 0.6 MPa (30 to 90 psi).

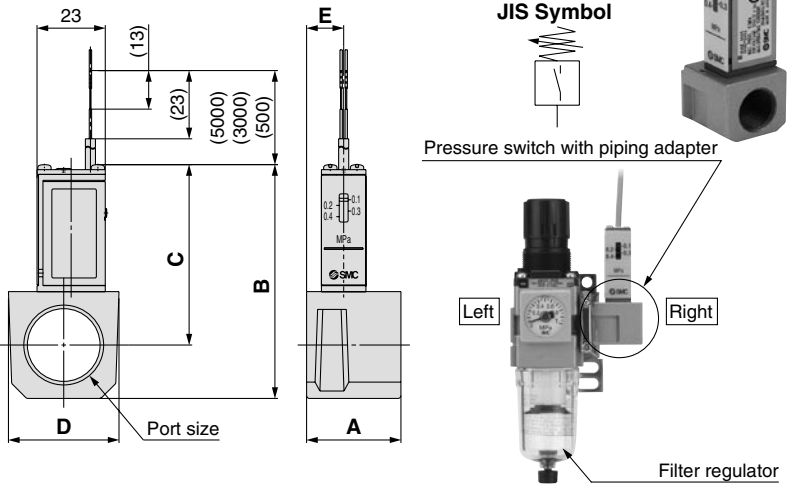

Model	Port size	A	B	C	D	E	Applicable model
IS10E-20□01	1/8	30	66	55	28	16	AC20□
IS10E-20□02	1/4						AR20□, AW20□
IS10E-20□03	3/8						AWM20, AWD20
IS10E-30□02	1/4	32	73	59	30	13	AC25□, AC30□
IS10E-30□03	3/8						AR25□, AR30□, AW30□
IS10E-30□04	1/2						AWM30, AWD30
IS10E-40□02	1/4	32	79	61	37	13	Note 2)
IS10E-40□03	3/8						AC40□
IS10E-40□04	1/2						AR40□, AW40□
IS10E-40□06	3/4						AWM40, AWD40

Note 1) □ in the model numbers indicates a thread type. No indication is necessary for Rc; however, indicate N for NPT, and F for G.
Note 2) Cannot be mounted to the AC40□-06 and AW40□-06.
Note 3) Prepare a spacer separately for modular connection.
* The pressure switch can be mounted on the AC40□-06 and above and the AW40□-06 by screwing the IS10-01 into the piping adapter E500-□06-X501 or E600-□06-X501 to E600-□10-X501 (Rc1/8 threaded on top surface). Products with a premounted switch are available as a special order. Please contact SMC beforehand.

For details, refer to "Modular/F.R.L. Units, Series AC" in Best Pneumatics No.5.

Safety Instructions

These safety instructions are intended to prevent hazardous situations and/or equipment damage. These instructions indicate the level of potential hazard with the labels of “**Caution**,” “**Warning**” or “**Danger**.” They are all important notes for safety and must be followed in addition to International Standards (ISO/IEC)*1), and other safety regulations.

Caution:

Caution indicates a hazard with a low level of risk which, if not avoided, could result in minor or moderate injury.

Warning:

Warning indicates a hazard with a medium level of risk which, if not avoided, could result in death or serious injury.

Danger :

Danger indicates a hazard with a high level of risk which, if not avoided, will result in death or serious injury.

- *1) ISO 4414: Pneumatic fluid power – General rules relating to systems.
ISO 4413: Hydraulic fluid power – General rules relating to systems.
IEC 60204-1: Safety of machinery – Electrical equipment of machines.
(Part 1: General requirements)
ISO 10218-1: Manipulating industrial robots - Safety.
etc.

Warning

1. The compatibility of the product is the responsibility of the person who designs the equipment or decides its specifications.

Since the product specified here is used under various operating conditions, its compatibility with specific equipment must be decided by the person who designs the equipment or decides its specifications based on necessary analysis and test results. The expected performance and safety assurance of the equipment will be the responsibility of the person who has determined its compatibility with the product. This person should also continuously review all specifications of the product referring to its latest catalogue information, with a view to giving due consideration to any possibility of equipment failure when configuring the equipment.

2. Only personnel with appropriate training should operate machinery and equipment.

The product specified here may become unsafe if handled incorrectly. The assembly, operation and maintenance of machines or equipment including our products must be performed by an operator who is appropriately trained and experienced.

3. Do not service or attempt to remove product and machinery/equipment until safety is confirmed.

- The inspection and maintenance of machinery/equipment should only be performed after measures to prevent falling or runaway of the driven objects have been confirmed.
- When the product is to be removed, confirm that the safety measures as mentioned above are implemented and the power from any appropriate source is cut, and read and understand the specific product precautions of all relevant products carefully.
- Before machinery/equipment is restarted, take measures to prevent unexpected operation and malfunction.

4. Contact SMC beforehand and take special consideration of safety measures if the product is to be used in any of the following conditions.

- Conditions and environments outside of the given specifications, or use outdoors or in a place exposed to direct sunlight.
- Installation on equipment in conjunction with atomic energy, railways, air navigation, space, shipping, vehicles, military, medical treatment, combustion and recreation, or equipment in contact with food and beverages, emergency stop circuits, clutch and brake circuits in press applications, safety equipment or other applications unsuitable for the standard specifications described in the product catalogue.
- An application which could have negative effects on people, property, or animals requiring special safety analysis.
- Use in an interlock circuit, which requires the provision of double interlock for possible failure by using a mechanical protective function, and periodical checks to confirm proper operation.

Caution

1. The product is provided for use in manufacturing industries.

The product herein described is basically provided for peaceful use in manufacturing industries.

If considering using the product in other industries, consult SMC beforehand and exchange specifications or a contract if necessary.

If anything is unclear, contact your nearest sales branch.

Limited warranty and Disclaimer/ Compliance Requirements

The product used is subject to the following “Limited warranty and Disclaimer” and “Compliance Requirements”.

Read and accept them before using the product.

Limited warranty and Disclaimer

- The warranty period of the product is 1 year in service or 1.5 years after the product is delivered.*2)
Also, the product may have specified durability, running distance or replacement parts. Please consult your nearest sales branch.
- For any failure or damage reported within the warranty period which is clearly our responsibility, a replacement product or necessary parts will be provided.
This limited warranty applies only to our product independently, and not to any other damage incurred due to the failure of the product.
- Prior to using SMC products, please read and understand the warranty terms and disclaimers noted in the specified catalogue for the particular products.

*2) Vacuum pads are excluded from this 1 year warranty.

A vacuum pad is a consumable part, so it is warranted for a year after it is delivered. Also, even within the warranty period, the wear of a product due to the use of the vacuum pad or failure due to the deterioration of rubber material are not covered by the limited warranty.

Compliance Requirements

- The use of SMC products with production equipment for the manufacture of weapons of mass destruction (WMD) or any other weapon is strictly prohibited.
- The exports of SMC products or technology from one country to another are governed by the relevant security laws and regulations of the countries involved in the transaction. Prior to the shipment of a SMC product to another country, assure that all local rules governing that export are known and followed.

Safety Instructions

Be sure to read “Handling Precautions for SMC Products” (M-E03-3) before using.

SMC Corporation (Europe)

Austria	☎ +43 2262622800	www.smc.at	office@smc.at
Belgium	☎ +32 (0)33551464	www.smc.be	info@smcpneumatics.be
Bulgaria	☎ +359 29744492	www.smc.bg	office@smc.bg
Croatia	☎ +385 13776674	www.smc.hr	office@smc.hr
Czech Republic	☎ +420 541424611	www.smc.cz	office@smc.cz
Denmark	☎ +45 70252900	www.smc.dk	smc@smcdk.com
Estonia	☎ +372 6510370	www.smc.ee	smc@smcpneumatics.ee
Finland	☎ +358 207513513	www.smc.fi	smc@smc.fi
France	☎ +33 (0)164761000	www.smc-france.fr	contact@smc-france.fr
Germany	☎ +49 (0)61034020	www.smc-pneumatik.de	info@smc-pneumatik.de
Greece	☎ +30 210 2717265	www.smc.gr	sales@smc.gr
Hungary	☎ +36 23511390	www.smc.hu	office@smc.hu
Ireland	☎ +353 (0)14039000	www.smc.ie	sales@smcpneumatics.ie
Italy	☎ +39 (0)292711	www.smc.it	mailbox@smc.it
Latvia	☎ +371 67817700	www.smc.lv	info@smc.lv

Lithuania	☎ +370 5 2308118	www.smc.lt	info@smc.lt
Netherlands	☎ +31 (0)205318888	www.smc.nl	info@smcpneumatics.nl
Norway	☎ +47 67129020	www.smc-norge.no	post@smc-norge.no
Poland	☎ +48 222119600	www.smc.pl	office@smc.pl
Portugal	☎ +351 226166570	www.smc.pt	post@smc.pt
Romania	☎ +40 213205111	www.smc-romania.ro	smcromania@smcromania.ro
Russia	☎ +7 8127185445	www.smc-pneumatik.ru	info@smc-pneumatik.ru
Slovakia	☎ +421 413213212	www.smc.sk	office@smc.sk
Slovenia	☎ +386 73885412	www.smc.si	office@smc.si
Spain	☎ +34 945184100	www.smc.es	post@smc.es
Sweden	☎ +46 (0)86031200	www.smc.se	post@smcpneumatics.se
Switzerland	☎ +41 (0)523963131	www.smc.ch	info@smc.ch
Turkey	☎ +90 (0)212440762	www.entek.com.tr	smc@entek.com.tr
UK	☎ +44 (0)845 121 5122	www.smc.co.uk	sales@smcpneumatics.co.uk