

# Precision rail guides

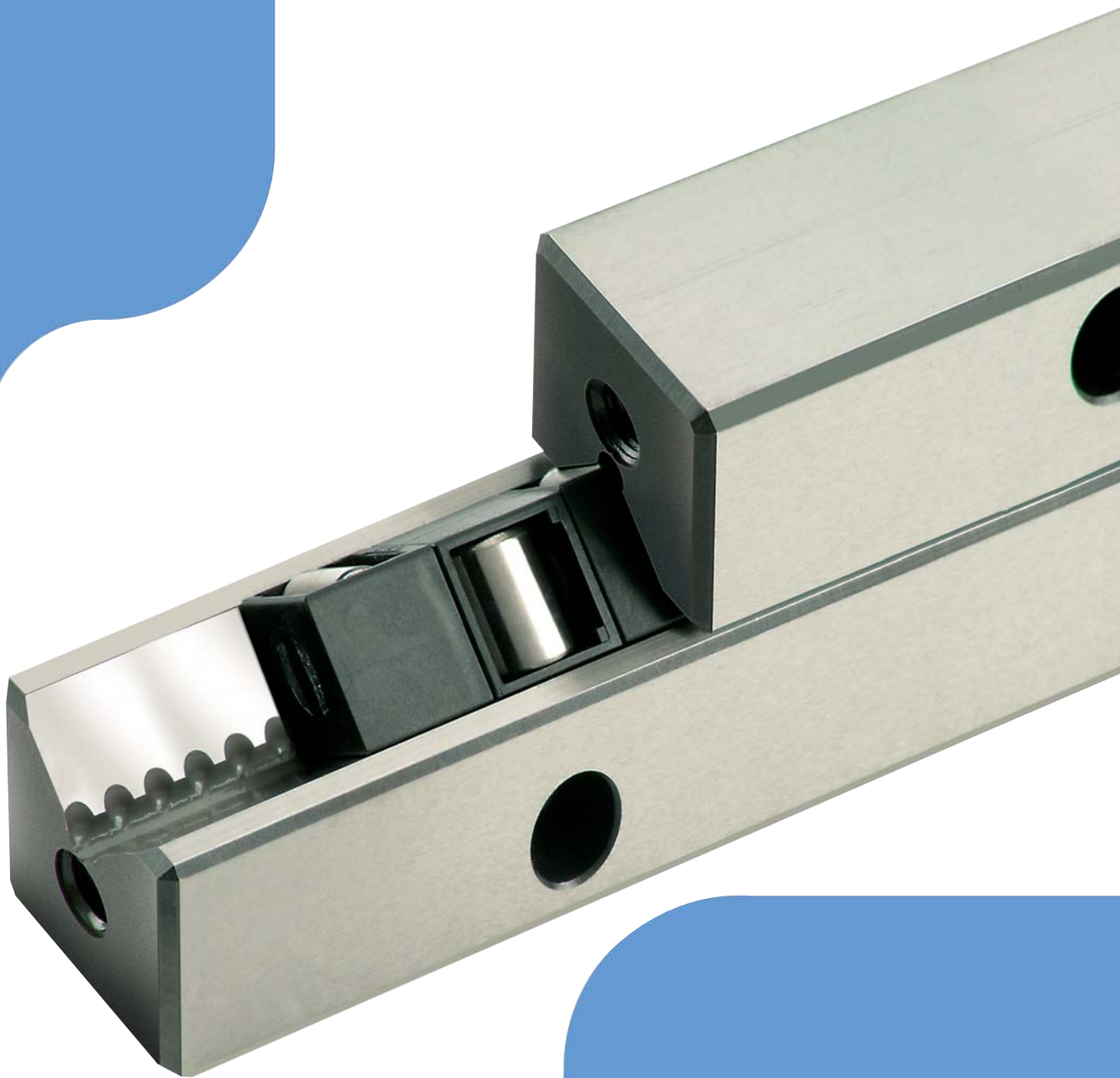



The SKF® brand now stands for more than ever before, and means more to you as a valued customer.

While SKF maintains its leadership as the hallmark of quality bearings throughout the world, new dimensions in technical advances, product support and services have evolved SKF into a truly solutions-oriented supplier, creating greater value for customers.

These solutions encompass ways to bring greater productivity to customers, not only with breakthrough application-specific products, but also through leading-edge design simulation tools and consultancy services, plant asset efficiency maintenance programmes, and the industry's most advanced supply management techniques.

The SKF brand still stands for the very best in rolling bearings, but it now stands for much more.

**SKF – the knowledge engineering company**

# Content

## General information

- 3 Introduction
- 4 Produkt overview
- 4 Modular Range rail guides
- 8 Other products

## Technical data

- 9 Precision of rail guides
- 9 Raceway accuracy
- 9 Dimensional accuracy
- 10 Grading
- 10 Tolerance of distance between attachment holes
- 10 Marking of matches sets
- 11 Accuracy of adjacent components
- 11 Selection of rail guides

## SKF precision rail guides in kit packaging

- 12 Rail guides in kit packaging
- 12 Advantages of rail guide kits
- 12 LWR rail guides in kit packaging - table
- 13 LWRE rail guides in kit packaging - table
- 13 LWRE ACS rail guides in kit packaging (supplied to order) - table

## LWR rail guides

- 14 LWR rail guides with crossed roller assemblies
- 14 LWR rail guides with ball assembly
- 15 Ball and crosses roller assemblies
- 18 Accessories for LWR rail guides

## LWRE rail guides

- 20 LWRE rail guides
- 21 Crossed roller assemblies
- 21 Special attachment screws
- 22 LWRE 3 - LWRE 9 / LWRE 2211
- 24 Accessories for LWRE rail guides
- 25 LWRE ACS rail guides with non-slip cage (Anti Creep System)
- 26 Accessories for LWRE ACS rail guides

## LWRM/LWRV rail guides

- 29 LWRM/LWRPV rail guides
- 30 LWRM/LWRV 6 and LWRM/LWRV 9
- 32 Accessories for LWRPM/LWRPV rail guides

## LWRPM/LWRPV rail guides

- 33 LWM/LWV rail guides
- 34 LWRPM/LWRPV 3 - LWRPM/LWRPV 9
- 36 Accessories for LWRPM/LWRPV rail guides

## LWM/LWV rail guides

- 37 LWRPM/LWRPV rail guides
- 38 LWM/LWV 3015 - LWM/LWV 8050
- 40 Accessories for LWM/LWV rail guides

## LWJ/LWS flat rail guides

- 41 LWJ/LWS flat rail guides

## LZM miniature slide

- 42 LZM miniature slide

## Standard slides

- 44 Design and characteristic features
- 45 Technical data
- 46 GCL - Drill hole pattern in top plate
- 47 GCL - Drill hole pattern in base plate

# Introduction

As the world's leading rolling bearing manufacturer, SKF supplies practically every type of bearing for rotational and linear motion.

SKF is therefore in a position to meet almost any customer requirement both technically and economically.

This catalogue covers the SKF range of precision rail guides and accessories.

SKF precision rail guides are highly accurate products for linear motion and are therefore ideally suited for use in a wide variety of machine tools, machining centres, handling systems and special machinery as well as measuring and testing equipment.

The "Modular Range" has introduced a new concept to the market, ensuring the internal interchangeability of all well-known guidance systems including the high capacity LWRE-type rail guides. This matrix range of rail guide modules permits the individual selection of rails and rolling elements.

SKF precision rail guides are available in many different designs, sizes and standard lengths, incorporating ball, roller or needle roller assemblies and slide coating. They are supplied with the required accessories for attachment and sealing.

The use of SKF precision rail guides facilitates the construction of economical, clearance-free linear guides of practically any type and length, according to the building block principle. The characteristics of the guides include:

- a constant, high degree of running accuracy
- low-friction, stick-slip free operation
- high speed of travel
- low heat generation
- low wear and high reliability
- high stiffness
- excellent load carrying capacity

If there is a danger of cage-creep (in particular when the guide is mounted vertically), precision rail guides of type LWRE-ACS (Anti-Creep System) are an obvious choice, as they will eliminate this problem.

For applications that are characterised by high accelerations or short strokes of high frequency, SKF rail guides with dry sliding coating are recommended.

These rail guides are also suitable for machine tool applications where the good damping properties of the guides are of greater importance than the lower friction of the rolling element rail guides. For those applications where rail guides are unsuitable, for instance because of their limited travel, SKF can supply alternative forms of linear guidance systems.

All fast-selling precision rail guides are also available in convenient kit packaging. This ensures complete delivery of all single components including end pieces and screws. If you would like further details, please contact the SKF application engineering department. We will be pleased to provide the required information without obligation and at no cost, or to prepare a technical proposal.

This catalogue brings together all the basic data which we consider to be of interest. For further specialised advice please contact your nearest SKF sales office.

# Product overview

## SKF modular range rail guides

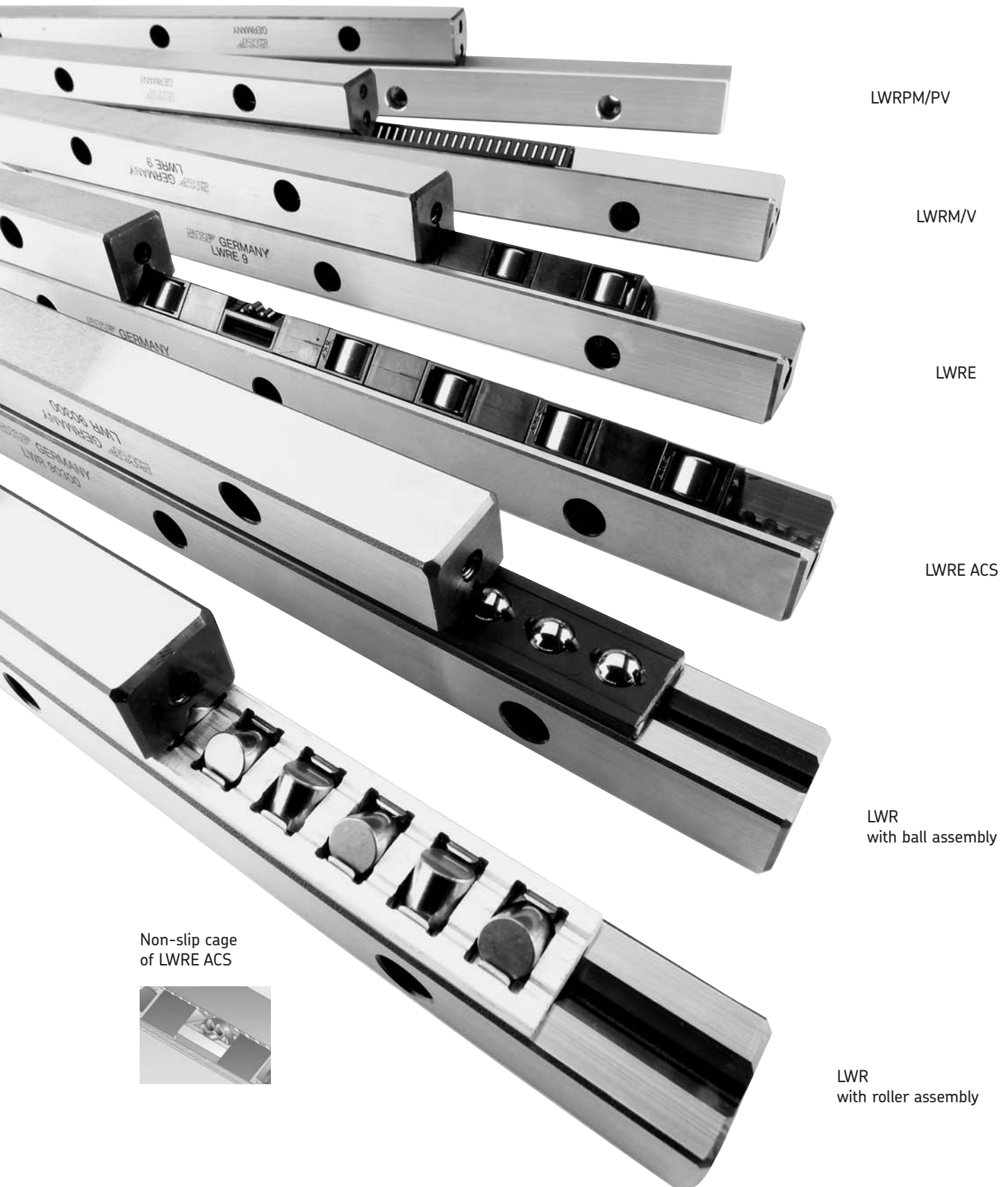

Non-slip cage  
of LWRE ACS

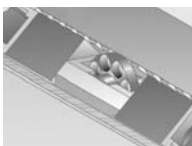

### SKF modular range rail guides

The SKF modular range consists of a matrix range of rail guide modules that enables individual permutations of rails and rolling element assemblies. Different requirements for the guides do not call for changes in the design or mechanical environment. The choice of appropriate rail guides is determined solely by the mechanical conditions under which the guide system is to operate. These operating requirements are covered by six different models (Fig. 1) that may be defined as rail guides with:

- crossed roller assemblies of the standard LWR series
- ball assemblies of the LWRB series
- crossed roller assemblies of the optimised LWRE series
- crossed roller assemblies with non-slip cage to prevent cage-creep of the LWRE ACS series
- needle roller assemblies of the LWRM/LWRV series and
- slide coating of the LWRPM/LWRPV series

The blue shaded areas in the chart indicate the sizes included in the Modular Range. Experience has shown that some 80 % of applications can be covered by these (Fig. 2).

Contrary to the current lack of uniformity within the market, the standard, interchangeable guidance systems of the Modular Range cover almost the entire spectrum of rail

guide applications. The choice of a specific rolling element or, for extreme conditions, of a slide coating, is determined only by the actual operating conditions (Fig. 5). Generally, any rail guide can be operated in the 'clamped' or 'floating' mode. The design of the rail guides does not impose any special space requirements.

Fig. 2

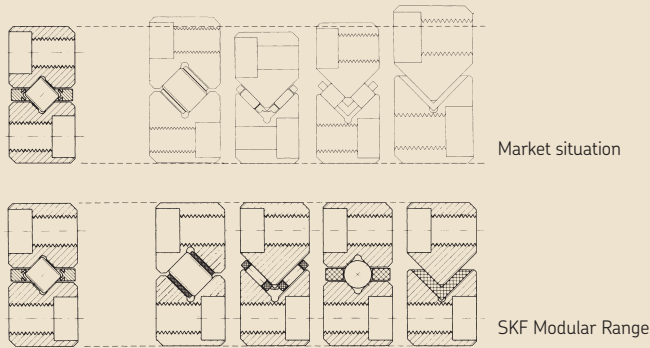
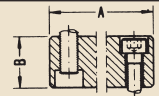

Fig. 1

		A x B										
Type	Size	8.5 x 4	12 x 6	18 x 8	22 x 11	25 x 12	31 x 15	44 x 22	58 x 28	71 x 36	83 x 40	110 x 55
		1	2	3	2211	4	6	9	12	15	18	24
LWR	LWR	-	-	X	-	-	X	X	0	0	0	0
LWRE	LWRE	-	-	X	0	X	X	X	-	-	-	-
LWRE ACS	LWRE ACS	-	-	X	0	0	0	0	-	-	-	-
LWRV	LWRM	-	-	-	-	-	0	0	0	0	-	-
LWRPV	LWRPM	-	-	0	-	-	0	0	0	0	-	-
LWRB	LWRB	X	X	-	-	-	-	-	-	-	-	-

= Modular Range

X = available ex-stock in standard lengths  
 0 = available to order  
 - = not available

### Increased performance achievable without design modification

The Modular System is based on the well-proven LWR design which covers a wide range of applications. The new optimised LWRE series offers either doubled stiffness and a load carrying capacity increased by a factor of five or, alternatively, for a given load carrying capacity, a 50 % reduction in bearing size compared with the standard LWR design (Fig. 3).

Fig. 3

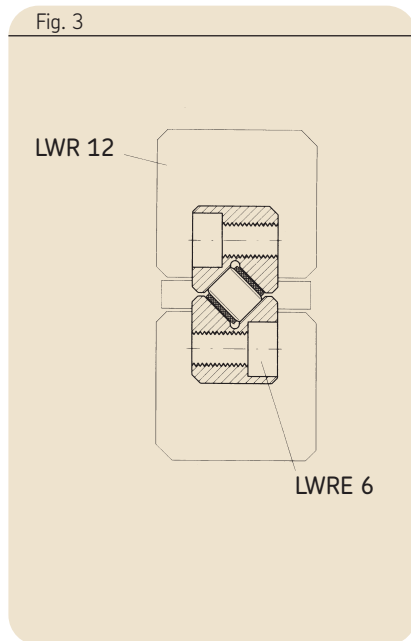

### Complete range

In order to further simplify the application of Modular Range rail guides, all guides within a given size range have the same external dimensions and thus fit the space requirements of most commercially available rail guides. This results in a very wide choice in terms of load carrying capacity, stiffness and operating characteristics.

From the economical point of view, the use of the optimised LWRE series offers a double advantage.

Firstly (although the initial cost is slightly higher) the range of application is extended significantly as regards stiffness and load carrying ca-

capacity. It thus offers a far better price/performance ratio. Secondly, the replacement of other rail guides, including those supplied by other manufacturers and already installed, can be carried out with ease and in a minimum of time.

Above all, where the user needs to increase machine performance, a unit with a higher load rating can be fitted. In-situ replacement is made easier by the fact that no new attachment holes or fixing devices are required when using rail guides of the Modular Range. An additional advantage is the worldwide availability through distributors, simply by quoting the appropriate catalogue number. The internal design of the LWRE series ensures increased operational life through even distribution of load. This results from the optimisation of the cross-section which permits the use of larger rolling elements. The new design leads to a significant improvement in the roller/raceway contact performance. An important additional benefit is the introduction of a practically maintenance-free cage made of POM that matches the stringent demands for long operational life of the rolling elements and maintains its dimensional stability up to +80 °C. The individual rollers are well covered and the space between the rails is almost filled, thus providing good protection against contamination. A special characteristic of the LWAKE 3, 6 and 9 cages is that they consist of 'snap-on' elements and can be fitted together to the required length (Fig. 4). Conventional crossed roller cages have their rollers arranged alternately evenly spaced, so that only half the rollers in a preloaded guide are load-bearing while the remainder act as idlers. In the new LWRE cage these essentially unused rollers can be partially turned in the direction of the load. For this purpose each individual cage segment is designed to

Fig. 4

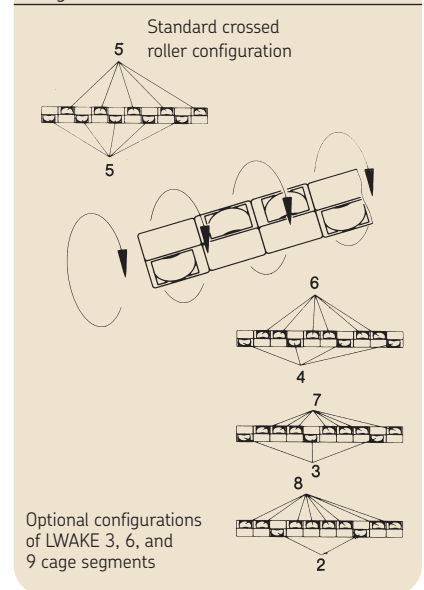

be turned through 90° about the longitudinal axis. These are manual adjustments and no special instructions are required when ordering from the catalogue.

LWAKE 4 crossed roller cages consist of roller segments that are assembled according to the length specified by the customer.

Fig. 5

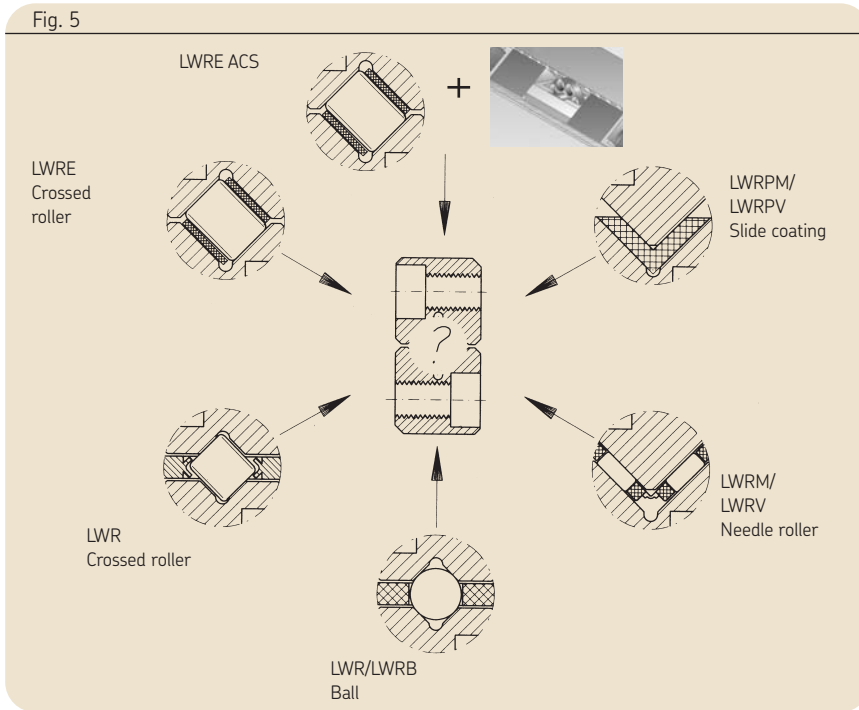

### LWR/LWRB series

This basic series of the Modular Range covers a wide variety of rail guide applications for limited travel. Where low friction is essential, ball cage assemblies are recommended. If, on the other hand, high load carrying capacity is the chief requirement, robust crossed roller assemblies are to be preferred. The LWR series is manufactured in nine sizes based on rolling element dimensions.

### LWRE series

For a given load carrying capacity, the dimensions of the LWRE series are significantly less than those of the corresponding member of the LWR series. Thus, for instance, an LWRE 6 guide with a cage length of 100 mm has a greater load carrying capacity than a standard LWR 12. The LWR 12 measures 58 x 28 mm whereas the LWRE 6 measures only 31 x 15 mm (Fig. 1).

### LWRE ACS series

All rails of the LWRE series are also available with ACS, a special system to prevent “cage-creep”. These rails are used where cage-creep occurs due to high acceleration, uneven preloading or load distribution as well as jerky running or direction-dependent speeds of travel.

### LWRM/LWRV series

These guides are used principally where high load carrying capacity is called for in combination with high stiffness, for instance on grinding machines. This series is fitted with needle roller and cage assemblies consisting of two rows of needle rollers at right angles to each other.

### LWRPM/LWRPV series

Where extremely short strokes of high frequency occur, this special series with slide coating is an essential alternative to those with rolling element assemblies. In the case of balls or rollers subjected to high transverse acceleration, pitting of the tracks

may occur as a result of the unfavourable tribological conditions. Sliding rail guides are preferred in such circumstances.

The coating material is based on PTFE and is bonded on to the unhardened LWRPM rail and then ground to the correct dimension.

This wear-resistant material combination is characterised by its stick-slip-free, vibration-damping running properties, at the same time offering excellent stiffness and emergency running properties. These guide rails are largely insensitive to contamination, coolants and lubricants.

### Materials and precision

The rails of the Modular Range guides are manufactured from tool steel 90 MnCrV 8 with a hardness of between 58 and 64 HRC. If required by the application, the rails can also be supplied in special stainless steel, e.g. X 90 CrMoV 18 in all standard dimensions. All rolling elements are made from carbon chromium steel 100 Cr 6 with a hardness of between 58 and 64 HRC. The parallelism of the raceways is divided into three classes. Class P10, with a maximum deviation of 10 µm per 1 000 mm length, meets most of the demands for normal machinery. Where greater precision is required, tolerance classes P5 and P2 are also available.

The assortment is complemented by various accessories specially designed for the Modular Range of rail guides. These include end pieces with or without wipers as well as special attachment screws.

### Other products

In addition to the Modular Range, the selection of SKF products also includes a wide variety of rail guides and rolling elements.

### LWM/LWV rail guides

(see table on pages 38-40)

LWM/LWV rail guides differ from the LWRM/LWRV guides of the Modular Range only in their external dimensions. Their internal geometry is identical and the same needle roller assemblies are therefore used.

In contrast to LWRM/LWRV (two series), the LWM/LWV guides comprise 6 series up to a size of  $A \times B = 80 \text{ mm} \times 50 \text{ mm}$ . LWM/LWV rail guides are supplied as standard with holes of type 15, namely through holes with counterbore. If for design reasons it is necessary to screw both rails from the same side, then one of the rails should have holes of type 13, i.e. with thread insert.

### LWML rail guides

(no table)

The LWML rail guide consists of a modified LWM rail guide with the addition of an adjustment wedge. Used in conjunction with an LWV guide and a needle roller assembly this provides an adjustable guide unit. The inclination of the wedge surface is 1,5 % so that a displacement of the wedge by 1 mm brings about a 15  $\mu\text{m}$  alteration in the height.

LWML rail guides are supplied as standard with holes of type 15, i.e. through holes with counterbore. If required holes of type 13, i.e. with thread insert, are also available. LWML rail guides can be supplied to tolerance classes P10 and P5. These guides, as well as the appropriate needle roller assemblies and end pieces, are made to order. Because of the many permutations available, each part of an LWML/LWV rail guide must be ordered separately, e.g.:

1 rail LWML 55200400  
1 rail LWM 40200400  
2 rails LWV 40200400  
2 end pieces LWEML 4020  
2 end pieces LWEM 4020

It should also be stated whether the holes should comprise right-hand or left-hand threads.

### LWN/LWO rail guides

(no table)

LWN/LWO rail guides differ from the LWM/LWV rail guides only in height, width and attachment holes. The internal geometry is identical to that of the LWM/LWV guides, i.e. they have the same load rating. LWN/LWO rail guides are available in tolerance classes P10, P5 and P2 to order.

### LWW/LWZ flat rail guides

(no table)

LWW/LWZ flat rail guides are used in conjunction with LWR rail guides for incorporation in floating slides. LWW/LWZ flat rail guides and the appropriate rolling element assemblies and end pieces are available to order.

### LWJ/LWS flat rail guides

(no table)

LWJ/LWS flat rail guides are used in conjunction with LWRM/LWRV, LWM/LWV or LWN/LWO rail guides as non-locating linear guides. They are incorporated in floating slides. LWJ/LWS flat rail guides as well as the appropriate rolling element assemblies and end pieces are available to order.

### Special rail guides and recirculating roller assemblies

In addition to the standard rail guides included in this catalogue, SKF also manufactures flat rail guides with recirculating roller assemblies as well as special rail guides to customer drawings for such applications as machine tools, handling systems

and robotics. Further information on these special versions and their availability will be supplied on request.



# Technical data

## Precision of rail guides

All SKF precision rail guides, regardless of type, are manufactured to the same tolerances indicated below.

## Raceway accuracy

In order to meet the different requirements regarding the precision of linear bearing arrangements, the rails are produced in three different tolerance classes. These are classified according to the parallelism between the raceways and the support surfaces A and B (Fig. 6).

### P10

Tolerance class normal. This meets the requirements of general engineering applications. The deviation from parallelism for a 1 000 mm long rail is approximately 10 µm. See also adjacent table 1.

### P5

This satisfies the demands normally made on the running accuracy for machine tool applications. The deviation from parallelism for a 1 000 mm long rail is 5 µm maximum. See also adjacent table 1.

### P2

Accuracy for the most exacting demands. Rails made to this tolerance class should only be used when the associated components are made to a correspondingly high degree of precision. Rails to tolerance class P2 will be manufactured by SKF to special order. See also table 1.

If no mention is made of the requisite accuracy on the order, rails with normal P10 tolerances will be supplied.

## Dimensional accuracy

SKF precision rail guides with limited travel are produced to the following tolerances (Figs. 7 and 8):

Width A: 0/-0,3mm  
 Abutment height  
 $T = B1 + B2 \pm 0,02 \text{ mm}$   
 Rail height B: 0/-0,2 mm  
 Rail length L:  $L \leq 300 \pm 0,3$   
 $L > 300 \pm 0,001 \cdot L \text{ [mm]}$

For rails composed of two or more sections the tolerance for the total length is  $\pm 2 \text{ mm}$ .

SKF precision rail guides for recirculating roller assemblies are produced to the following tolerances:

Width A: 0/+0,1 mm  
 Height A: 0/+0,1 mm  
 Length L:  $L \leq 300 \pm 0,3$   
 $L > 300 \pm 0,001 \cdot L \text{ [mm]}$

Fig. 6

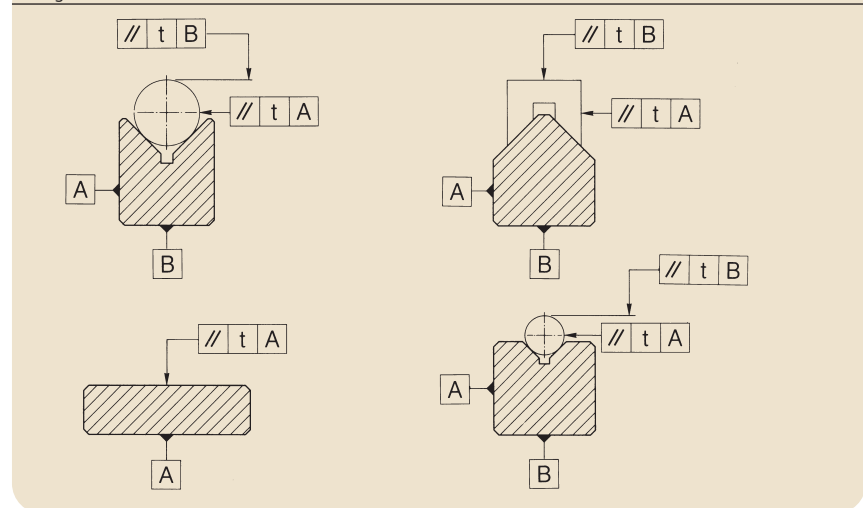

Table 1

Permissible deviation in parallelism between reference planes A and B

Rail length from	to	Tolerance class		
		P10	P5	P2
mm		µm		
	100	2	1	1
100	200	3	2	1
200	300	4	2	1
300	400	5	2	2
400	500	6	3	2
500	600	6	3	2
600	700	7	4	2
700	800	8	4	2
800	900	8	5	2
900	1 000	9	5	2
1 000	1 200	10	6	3
1 200	1 400	11	6	3
1 400	1 600*	12	7	3

\* Rail length > 1 600 mm, please contact SKF

### Grading

Precision rail guides with limited travel are generally mounted in pairs. In order to obtain the same assembly height  $T$  (Fig. 7), the rails are graded and supplied in pairs.

This ensures that any two similar rail guides in a system will have the same height.

If two or more rolling element assemblies are to be mounted immediately behind each other in a rail guide, the rolling elements must have the same tolerance grade. On request, graded rolling element assemblies can be supplied.

Rails of the same profile for recirculating roller assemblies, which are to be mounted immediately adjacent to each other or immediately behind each other should be ordered in graded condition. Depending on their type, they will be graded in height or in height and width and delivered as a single package.

Rail guide sets are always matched so that it is not necessary to request this when ordering.

### Tolerance of distance between attachment holes

The maximum deviation in the distance between the attachment holes measured from centre to centre is  $\pm 0,8\%$  of the rail length  $L$  for one-piece rails (Fig. 8). Where the rail consists of several sections, the tolerance is also  $\pm 0,8\%$ , related to the length of the longest section. Rails having tighter tolerances for the distance between the holes can be supplied on request.

### Marking of matched sets

Matched components are marked with consecutive numbers as indicated in Fig. 8a.

Fig. 7

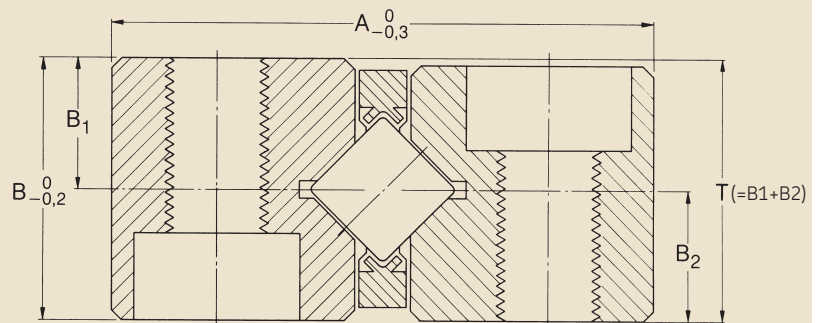

Fig. 8

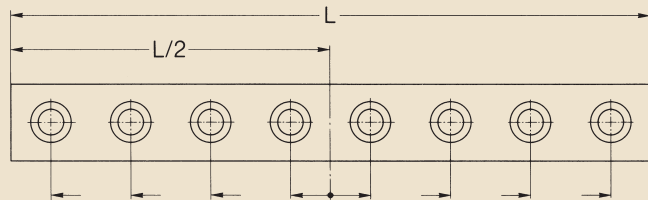
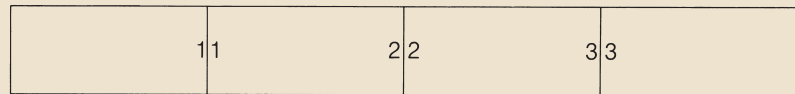

Fig. 8a



### Accuracy of adjacent components

An important criterion for the correct performance of a rail guide system is the accuracy of the associated components. The higher the demands for accuracy of guidance and for smooth, easy operation, the greater the attention which must be paid to the accuracy of form and position of the associated components. Generally the same accuracy requirements should be applied to these components as to the rail guides themselves. The adjacent table shows the values, for each tolerance class, of the surface roughness, perpendicularity and parallelism of the adjacent components.

To assure an even load distribution over the roller length, the maximum difference in height of the supports for a rail guide should not exceed

$$\Delta h = 0,1 \cdot B_1$$

where

$\Delta h$  = maximum height deviation,  $\mu\text{m}$

$B_1$  = mean distance between two rail guides, mm

To obtain good support for the rails on the associated components, the attachment holes should be carefully deburred (Figs. 9 and 10).

### Selection of rail guides

When selecting a rail guide, the length of travel, load carrying capacity, requisite life and stiffness are the most decisive factors. Other important parameters include the requisite speed of travel, lubrication, operating temperatures, ease of movement, environmental influences and certain design constraints, for instance whether "clamped" or "floating" guidance is required. If further information is needed, please contact SKF.

The selection of the size and length of the rolling element assemblies is mainly determined by the required

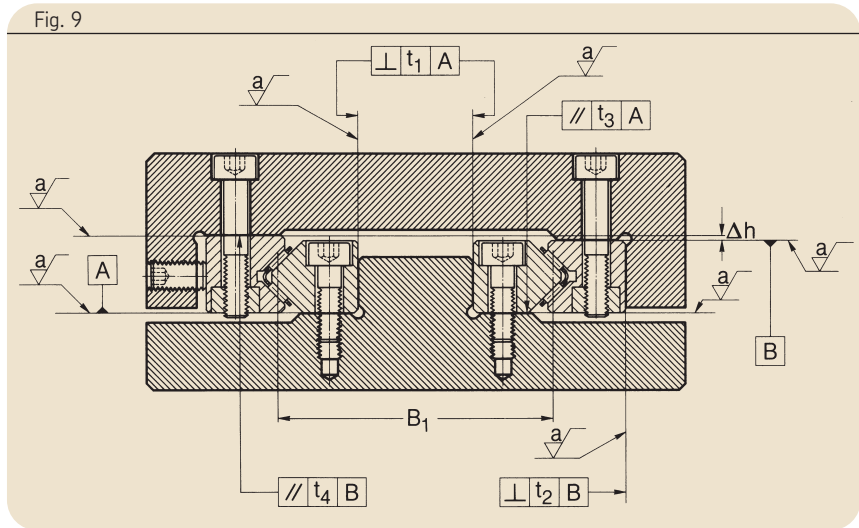

Fig. 10

### Accuracy of form of support surfaces

Characteristic	Symbol for		Dimensions	Permissible deviation of form		
	Charac- teristic	Tolerance zone		Tolerance class		
				P10	P5	P2
Roughness $R_a$		a	$\mu\text{m}$	1,6	0,8	0,2
Perpendicularity	⊥	$t_1/t_2$	$\mu\text{m}/\text{mm}$	0,3	0,3	0,3
Parallelism	//	$t_3/T_4$	$\mu\text{m}$	depending on the guide length L (mm)		
				3	2	1
				6	4	2
				10	6	3
						1 000

load carrying capacity, life and stiffness.

For light, centrally acting loads and moderate demands for speed of travel, it is possible to use practically all the types of guides listed in this catalogue. However, technical and economic reasons often dictate the choice of the most appropriate model for a given application.

The length of a rail guide and of the individual rails is mainly determined by the travel as well as the length of the rolling element assemblies, which depends on the requisite load carrying capacity and life.

The following relationships serve as guidelines for determining the

length of rail guides and rolling element assemblies:

For a given stroke:  
Cage length = stroke, at least

For a given cage length:  
Rail length = cage length  
+ 0,5 x stroke

For a given rail length and stroke, the cage length is obtained from:  
Cage length = Rail length  
- 0,5 x stroke

# SKF precision rail guides in kit packaging

## Rail guides in kit packaging

Kit packaging is a new service offered by SKF. Each kit consists of a four-piece rail guide set, 2 cages and 8 end pieces.

## Advantages of rail guide kits

- all required components are supplied in ready-to-mount sets and can be ordered via one single order number
- for enhanced ease of mounting, all parts can now be supplied directly to the machine on site
- cage length easily adjustable \*
- environmentally compatible packaging that can be returned free of charge and directed to the recycling process
- most kits available ex stock
- also available with ACS for the effective prevention of cage-creep



Certified in accordance with ISO 14001, SKF Linear Motion and the entire SKF Group attach great importance to environmental protection. Hence as a matter of course, SKF

kit packagings can be returned free of charge and are directed to the recycling process. This makes them both a convenient and an environmentally-friendly packaging solution.

## LWR rail guides in kit packaging

Designation	Load ratings		Stroke	Type of rail 4 pieces	Type of cage 2 pieces
	dyn. C	stat. C <sub>0</sub>			
	N		mm		
LWR 3050 Kit	999	1 120	26	LWR 3050	LWAK 3x7
LWR 3075 Kit	1 422	1 760	36	LWR 3075	LWAK 3x11
LWR 3100 Kit	1 811	2 400	46	LWR 3100	LWAK 3x15
LWR 3125 Kit	2 088	2 880	66	LWR 3125	LWAK 3x18
LWR 3150 Kit	2 442	3 520	76	LWR 3150	LWAK 3x22
LWR 3175 Kit	2 781	4 160	86	LWR 3175	LWAK 3x26
LWR 3200 Kit	3 110	4 800	96	LWR 3200	LWAK 3x30
including 8 end pieces LWERA 3					
LWR 6100 Kit	4 915	5 440	50	LWR 6100	LWAL 6x8
LWR 6150 Kit	6 744	8 160	78	LWR 6150	LWAL 6x12
LWR 6200 Kit	8 441	10 880	106	LWR 6200	LWAL 6x16
LWR 6250 Kit	10 045	13 600	134	LWR 6250	LWAL 6x20
LWR 6300 Kit	11 955	17 000	144	LWR 6300	LWAL 6x25
LWR 6350 Kit	13 422	19 720	172	LWR 6350	LWAL 6x29
LWR 6400 Kit	14 846	22 440	200	LWR 6400	LWAL 6x33
including 8 end pieces LWERA 6					

\* Note: Do not cut the cage (roller assembly) shorter than 2/3 of the total rail length.

# LWRE rail guides in kit packaging

Designation	Load ratings		Stroke	Type of rail 4 pieces	Type of cage 2 pieces
	dyn. C	stat. C <sub>0</sub>			
	N		mm		
LWRE 3050 Kit	4 230	5 100	25	LWRE 3050	LWAKE 3x6
LWRE 3075 Kit	5 803	7 650	38	LWRE 3075	LWAKE 3x9
LWRE 3100 Kit	7 263	10 200	50	LWRE 3100	LWAKE 3x12
LWRE 3125 Kit	8 644	12 750	63	LWRE 3125	LWAKE 3x15
LWRE 3150 Kit	9 964	15 300	75	LWRE 3150	LWAKE 3x18
LWRE 3175 Kit	11 238	17 850	88	LWRE 3175	LWAKE 3x21
LWRE 3200 Kit	12 471	20 400	100	LWRE 3200	LWAKE 3x24
including 8 end pieces LWERE 3					
LWRE 6100 Kit	25 743	27 300	46	LWRE 6100	LWAKE 6x7
LWRE 6150 Kit	34 000	39 000	80	LWRE 6150	LWAKE 6x10
LWRE 6200 Kit	44 204	54 600	92	LWRE 6200	LWAKE 6x14
LWRE 6250 Kit	51 431	66 300	126	LWRE 6250	LWAKE 6x17
LWRE 6300 Kit	58 382	78 000	160	LWRE 6300	LWAKE 6x20
LWRE 6350 Kit	67 304	93 600	172	LWRE 6350	LWAKE 6x24
LWRE 6400 Kit	73 781	10 5300	206	LWRE 6400	LWAKE 6x27
including 8 end pieces LWERE 6					

# LWRE ACS rail guides in kit packaging (supplied to order)

Designation	Load ratings		Stroke	Type of rail 4 pieces	Type of cage 2 pieces
	dyn. C	stat. C <sub>0</sub>			
	N		mm		
LWRE 3050 ACS - Kit	3 465	4 250	20	LWRE 3050 ACS	LWAKE 3 x 5 ACS
LWRE 3075 ACS - Kit	5 294	6 800	30	LWRE 3075 ACS	LWAKE 3 x 6 ACS
LWRE 3100 ACS - Kit	6 300	8 500	45	LWRE 3100 ACS	LWAKE 3 x 10 ACS
LWRE 3125 ACS - Kit	7 731	11 050	62	LWRE 3125 ACS	LWAKE 3 x 13 ACS
LWRE 3150 ACS - Kit	9 090	13 600	79	LWRE 3150 ACS	LWAKE 3 x 16 ACS
LWRE 3175 ACS - Kit	9 964	15 300	94	LWRE 3175 ACS	LWAKE 3 x 18 ACS
LWRE 3200 ACS - Kit	11 653	18 700	100	LWRE 3200 ACS	LWAKE 3 x 22 ACS
including 8 end pieces LWERE 3					
LWRE 6100 ACS - Kit	22 826	23 400	37	LWRE 6100 ACS	LWAKE 6 x 6 ACS
LWRE 6150 ACS - Kit	31 318	35 100	71	LWRE 6150 ACS	LWAKE 6 x 9 ACS
LWRE 6200 ACS - Kit	39 196	46 800	105	LWRE 6200 ACS	LWAKE 6 x 12 ACS
LWRE 6250 ACS - Kit	49 056	62 400	117	LWRE 6250 ACS	LWAKE 6 x 16 ACS
LWRE 6300 ACS - Kit	56 093	74 100	151	LWRE 6300 ACS	LWAKE 6 x 19 ACS
LWRE 6350 ACS - Kit	65 107	89 700	163	LWRE 6350 ACS	LWAKE 6 x 23 ACS
LWRE 6400 ACS - Kit	71 640	101 400	197	LWRE 6400 ACS	LWAKE 6 x 26 ACS
including 8 end pieces LWERE 6					

\* Note: Do not cut the cage (roller assembly) shorter than 2/3 of the total rail length.

# LWR rail guides

LWR rail guides are well-proven, limited-travel linear guides used in numerous applications. They consist of two identical rails between which crossed roller assemblies or ball assemblies are inserted, depending on the respective application.

LWR rail guides with crossed roller assemblies are robust linear bearings with high load carrying capacity. Their special characteristics make them suitable for a large proportion of linear bearing arrangements with limited travel.

LWR rail guides with ball assembly can be used to advantage where loads are light and/or easy running is required.

Rail guides with a length greater than 1 200 mm are supplied in sections.

Because of the many permutations available, each part of an LWR rail guide must be ordered separately, e. g:

- 4 rails LWR 90600
- 2 crossed roller assemblies LWAL 9x25
- 8 end pieces LWERA 9

## Ordering

To facilitate the order routine, rail guide sets can also be ordered in kit packaging (see pages 12-13).



### **Ball and crossed roller assemblies for LWR rail guides**

#### **Ball assemblies**

Where moderate loads are to be supported by a rail guide and greater priority is given to smooth operation and low friction, the use of ball assemblies is recommended.

**LWJK ball assemblies** are provided with a plastic ball-retaining cage. These are available for sizes 1 and 2.

#### **Crossed roller assemblies**

Where greater stiffness is required, crossed roller assemblies are recommended. Various cage types are available, depending on the size of the rollers.

**LWAK crossed roller assemblies** are fitted as standard for size 3 with a plastic cage to retain the cylindrical rollers.

**LWAL crossed roller assemblies** are available in sizes 6 to 12 with aluminium cages. They comprise retained rollers.

#### **End pieces for LWR rail guides**

End pieces prevent the drift of the cage away from the loaded zone.

**LWERA end pieces** fulfil these requirements in low-load conditions combined with horizontal mounting.

#### **Attachment screws for LWR rail guides**

In particular in the case of long rail guides, heat treatment can lead to thermal expansion which will also influence the distance between the tap holes. Special attachment screws compensate for this longitudinal expansion.

**LWGD special attachment screws** can be used for all rails within the Modular Range.

### **SKF modular range**

The LWR rail guides form the basis for the whole Modular Range system. All guides with designations commencing LWR... included in this catalogue are interchangeable with each other within a given dimension series. All external and attachment dimensions correspond with those of the LWR series.

LWR rail guides are available in a total of nine sizes. The "Modular Range" includes sizes 3, 6 and 9 which, according to experience, cover 80 % of the normal market requirements. To enable prompt delivery from stock, certain standard rail lengths have been defined.

SKF Modular Range rail guides are specially highlighted in the tables. For further information, please refer to pages 5 to 7.

# LWR rail guides

LWR 3 - LWR 12

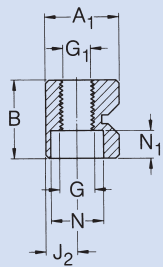
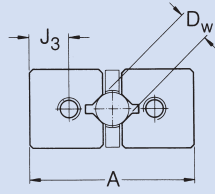
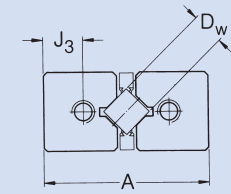

LWRB 1 + 2

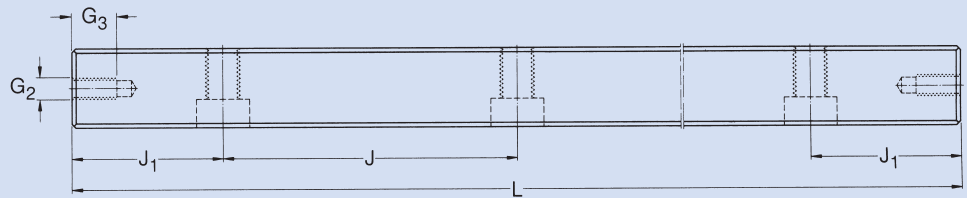
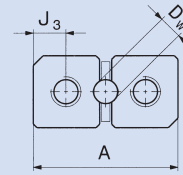

Designation	Dimensions: System				Mounting holes							End face holes			Available lengths					
	A	B	A <sub>1</sub>	D <sub>w</sub>	J	J <sub>1</sub>	J <sub>2</sub>	G	G <sub>1</sub>	N	N <sub>1</sub>	J <sub>3</sub>	G <sub>2</sub>	G <sub>3</sub>	L <sup>1)</sup>					
mm															020	030	040	045	050	060
LWRB 1	8,5	4	3,9	1,6	10	5	1,8	M2	1,65	3	1,4	1,9	M1,6	2	•	•	•	•	•	•
LWRB 2	12	6	5,5	2	15	7,5	2,5	M3	2,55	4,4	2	2,7	M2,5	3	•	•	•	•	•	•

Designation	Dimensions: System				Mounting holes							End face holes			Available lengths									
	A	B	A <sub>1</sub>	D <sub>w</sub>	J	J <sub>1</sub>	J <sub>2</sub>	G	G <sub>1</sub>	N	N <sub>1</sub>	J <sub>3</sub>	G <sub>2</sub>	G <sub>3</sub>	L <sup>1)</sup>									
mm															050	075	100	125	150	175	200	225	250	
LWR 3	18	8	8,2	3	25	12,5	3,5	M4	3,3	6	3,2	4	M3	6	■	■	■	■	■	■	■	○	•	
LWR 6	31	15	13,9	6	50	25	6	M6	5,2	9,5	5,2	7	M5	9	■	○	■	■	■	■	■	■	■	
LWR 9	44	22	19,7	9	100	50	9	M8	6,8	10,5	6,2	10	M6	9	■	■	■	■	■	■	■	■	■	
LWR 12	58	28	25,9	12	100	50	12	M10	8,5	13,5	8,2	13	M8	12	■	■	■	■	■	■	■	■	■	

<sup>1)</sup> Sizes LWR 15, 18 and 24 are available on request.



### Ball and crossed roller assemblies

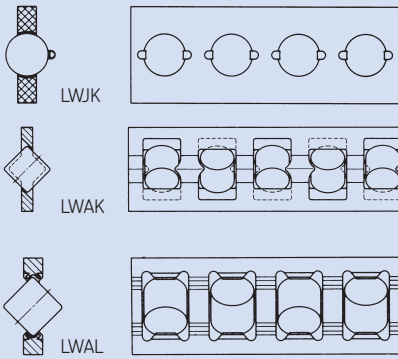

### End pieces

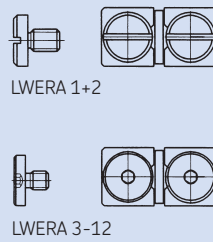

### Special attachment screws

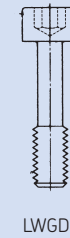

												Ball and crossed roller assemblies	End pieces <sup>1)</sup>	Special-attachment screws		
070	075	080	090	100	105	120	135	150					LWJK	LWERA	LWGD	
○	●	○	○	○	●	●	○	○					●	●		
													●	●		
												Ball and crossed roller assemblies	End pieces <sup>1)</sup>	Special-attachment screws		
275	300	350	400	450	500	550	600	650	700	800	900	1 000	LWJK	LWAL	LWERA	LWGD
○	●	●	●	●	○	○	○	○	○	○	○	○		●	●	●
■	■	■	■	■	○	○	○	○	○	○	○	○		●	●	●
○	○	○	○	○	○	●	○	○	○	○	○	○		●	●	●

- SKF Modular Range. Preferred range, prompt delivery
- Prompt delivery
- Available to order

Example: 4 LWR 3100 or 4 LWR 90200  
 2 LWAK 3 x 17 2 LWAL 9x10  
 8 LWERA 3 4 LWERA 9

# Accessories for LWR rail guides

## Ball and crossed roller assemblies

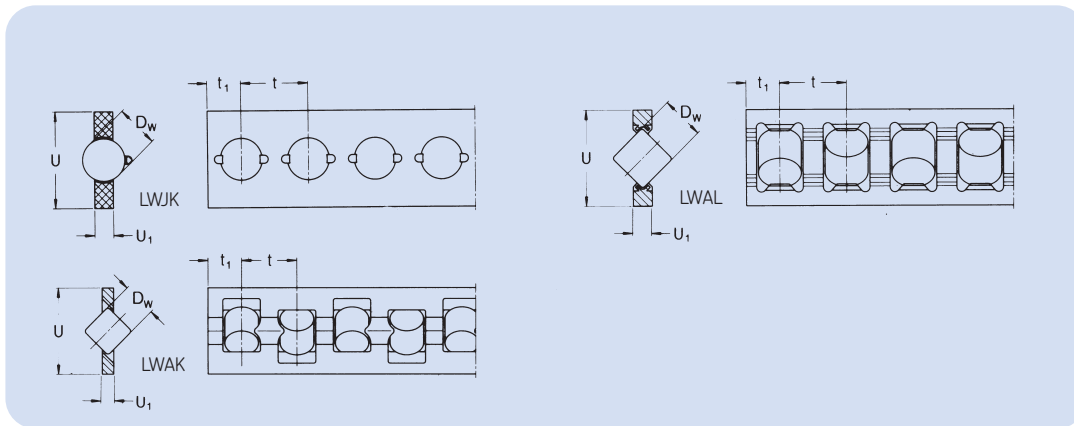

For description and data relating to rolling element assemblies, see page 15

Designation <sup>1)</sup>	Dimensions					Load ratings for 10 rolling elements		Appropriate rail guide
	D <sub>w</sub>	U	U <sub>1</sub>	t	t <sub>1</sub>	dynamic C	static C <sub>0</sub>	
	mm					N		
LWJK 1,588	1,588	3,5	0,5	2,2	1,0	410	580	LWRB 1
LWJK 2	2	5	0,75	3,9	1,5	640	720	LWRB 2
LWAK 3	3	7,5	1	5	3,5	1 320	1 600	LWR 3
LWAL 6	6	14,8	2,7	9	6	5 850	6 800	LWR 6
LWAL 9	9	20	4	14	9,4	17 000	18 300	LWR 9
LWAL 12	12	25	5	18	12	30 000	30 500	LWR 12

## End pieces

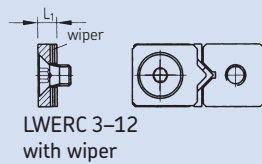
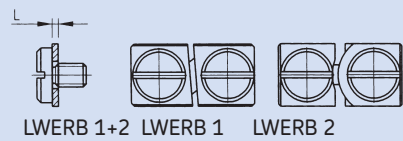
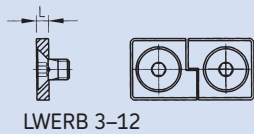
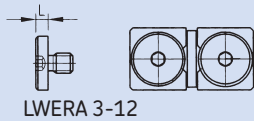
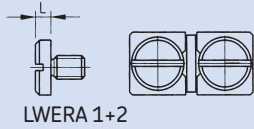

## Special attachment screws

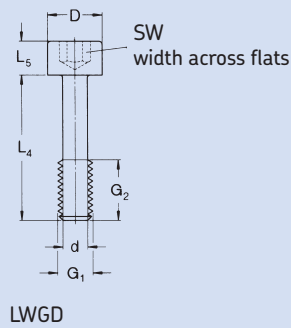

Designation		Dimensions		Appropriate attachment screw	Designation Special attachment screws	Dimensions							
End pieces	End pieces with wiper	L	L <sub>1</sub>			G1	G2	L4	L5	D	d	SW <sup>2)</sup>	
		mm		DIN 963	mm								
LWERA 1	–	1	–	M 1,6	–	–	–	–	–	–	–		
LWERB 1	–	0,5	–	M 1,6	–	–	–	–	–	–	–		
LWERA 2	–	1,5	–	M 2,5	–	–	–	–	–	–	–		
LWERB 2	–	0,5	–	M 2,5	–	–	–	–	–	–	–		
LWERA 3	–	2,5	–	M 3	LWGD 3	M 3	5	12	3	5	2,3	2,5	
LWERB 3	–	2	–	M 3									DIN 7991
–	LWERC 3	2	5	M 3									
–	–	–	–	–	LWGD 4 (für LWRE 4)	M 3	5	16	3	5	2,3	2,5	
LWERA 6	–	3	–	M 5	LWGD 6	M 5	8	20	5	8	3,9	4	
LWERB 6	–	3	–	M 5									DIN 7991
–	LWERC 6	3	6	M 5									DIN 7991
LWERA 9	–	4	–	M 6	LWGD 9	M 6	12	30	6	8,5	4,6	5	
LWERB 9	–	4	–	M 6									DIN 7991
–	LWERC 9	4	7	M 6									DIN 7991
LWERA 12	–	5	–	M 8	LWGD 12	M 8	17	40	8	11,3	6,2	6	
LWERB 12	–	5	–	M 8									DIN 7991
–	LWERC 12	5	8	M 8									DIN 7991

<sup>2)</sup> Width across flats of internal hexagon

# LWRE rail guides

LWRE rail guides are a logical development of the proven LWR rail guides. Within the Modular Range system the LWRE rail guides offer an outstanding price/performance ratio.

Alongside the familiar characteristics of the LWR series, the new LWRE rail guides offer the advantages of a fivefold increase in the load carrying capacity and a doubling of the stiffness, achieved through optimised internal geometry in conjunction with larger roller diameters.

LWRE rail guides offer a greatly increased safety margin, thus a very much smaller LWRE rail guide can be used in a given design space while maintaining the same load carrying capacity as the LWR.

The mounting and attachment dimensions of the LWRE rail guides conform to those of all the SKF Modular Range rail guides included in this catalogue.

Rail guides of more than 1 200 mm in length should be built up of sections. Because of the many permutations available, each part of an LWRE rail guide must be ordered separately, e.g.:

- 4 rails LWRE 6200
- 2 crossed roller assemblies LWAKE 6x13
- 4 end pieces LWERE 6

## Ordering

To facilitate the order routine, rail guide sets can also be ordered in kit packaging (see pages 12-13).



## Crossed roller assemblies for LWRE rail guides

LWAKE crossed roller cages consist of individual plastic elements.

In LWAKE 3, 6 and 9 cages, these elements are assembled using a 'snap in' technique whereby each element can be rotated manually through an angle of 90°. Thus the load rating and stiffness can be enhanced by turning the rollers in the direction of the load.

Dimensional stability of the LWAKE crossed roller assembly is maintained up to a temperature of +80 °C. The cage retains the rollers and at the same time almost fills the free space between the rails, thus providing good protection against the ingress of dirt.

LWAKE 4 cages consist of roller segments which are fitted together to the customer's specific length requirements.

End pieces for LWRE rail guides  
End pieces prevent the drift of the cage away from the loaded zone.

LWRE end pieces are generally used for horizontal and vertical applications.

All end pieces are supplied with appropriate fixing screws.

Special attachment screws for LWRE rail guides

For designations and dimensions please refer to the LWR table on page 19. The LWGD special attachment screws listed in the table may be selected to suit each size of LWRE rail guide.

## Internal geometry of LWR and LWRE rail guides

Normal LWR rail guides utilise only about 40 % of the roller length. Due to the parallel displacement of the load axes, LWR rail guides are prone to an internal tilting moment on the rollers. This can lead to high edge stresses and hence to a reduction of load carrying capacity. LWRE rail guides, on the other hand, utilise the whole roller length. Their internal geometry is such that no tilting moment can occur and there are no edge stresses.

At the same time the diameter of the rollers has been considerably increased (+33 %). These features provide the following advantages:

- fivefold increase in load carrying capacity
- 100 % increase in stiffness

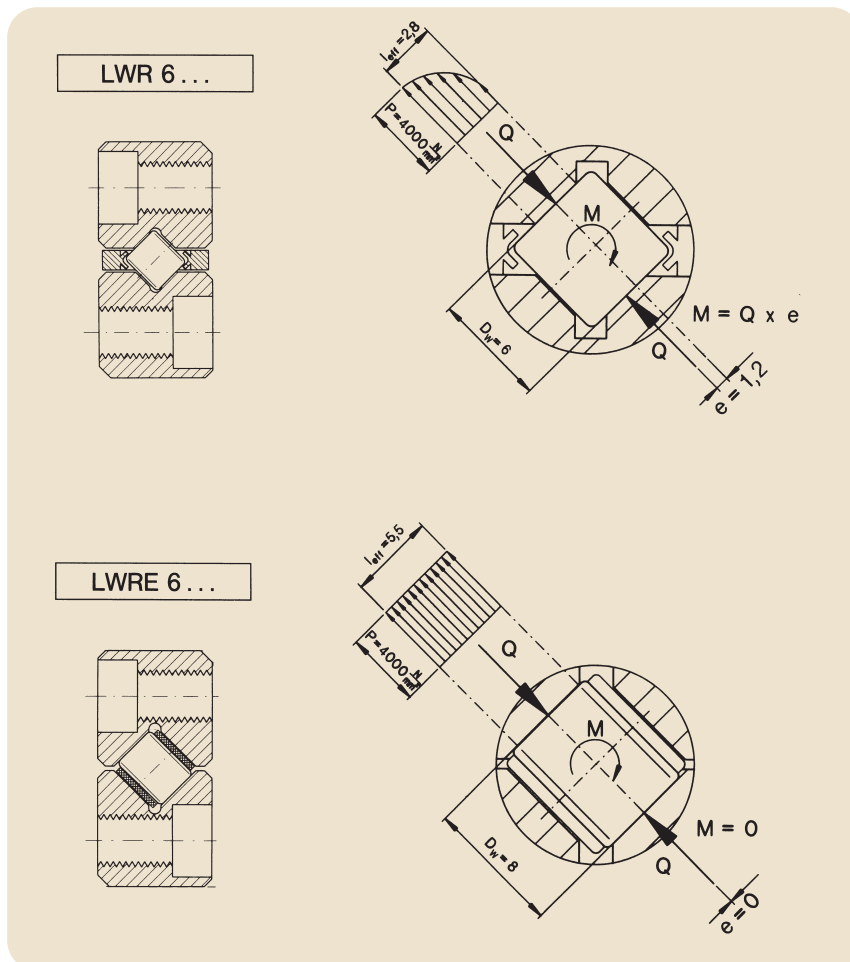

# LWRE rail guides

## LWRE 3 - LWRE 9 / LWRE 2211

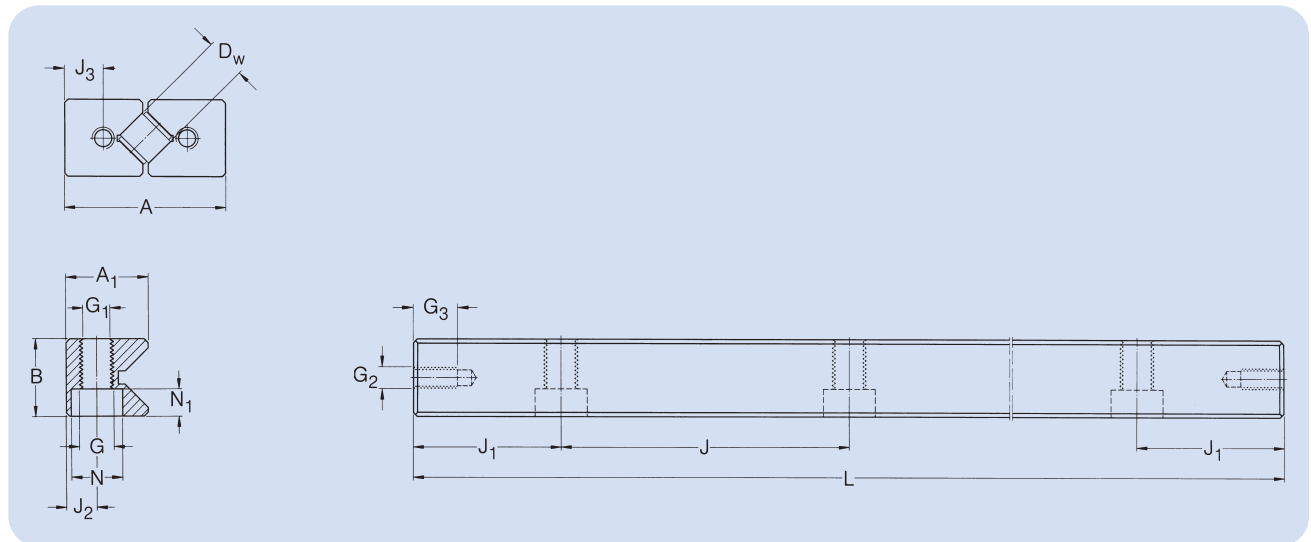

Designation	Dimensions: System				Attachment holes							End face holes			Available lengths							
	A	B	A <sub>1</sub>	D <sub>w</sub>	J	J <sub>1</sub>	J <sub>2</sub>	G	G <sub>1</sub>	N	N <sub>1</sub>	J <sub>3</sub>	G <sub>2</sub>	G <sub>3</sub>	L <sup>1)</sup>							
mm															050	075	100	125	150	175	200	
LWRE 3	18	8	8,7	4	25	12,5	3,5	M 4	3,3	6	3,2	4	M 3	6	■	■	■	■	■	■	■	■
LWRE 4	25	12	12	6,5	25	12,5	5	M 4	3,3	6	3,2	5	M 3	6			○		○		○	
LWRE 6	31	15	15,2	8	50	25	6	M 6	5,2	9,5	5,2	6,75	M 5	9			■		■		■	
LWRE 9	44	22	21,7	12	100	50	9	M 8	6,8	10,5	6,2	9,75	M 6	9								■

Designation	Dimensions: System				Attachment holes							End face holes			Available lengths							
	A	B	A <sub>1</sub>	D <sub>w</sub>	J	J <sub>1</sub>	J <sub>2</sub>	G	G <sub>1</sub>	N	N <sub>1</sub>	J <sub>3</sub>	G <sub>2</sub>	G <sub>3</sub>	L <sup>1)</sup>							
mm															080	120	160	200				
LWRE 2211	22	11	10,7	4	40	20	4,5	M 5	4,3	7,5	4,1	6	M 3	6	○	○	○	○				

<sup>1)</sup> Other lengths are available on request

### Crossed roller assemblies

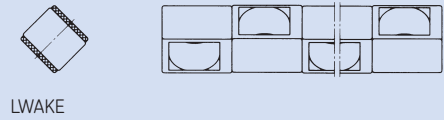

LWAKE

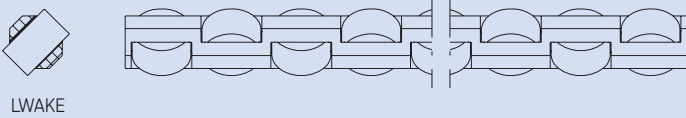

LWAKE

### End pieces

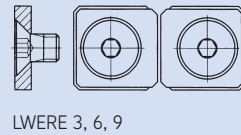

LWRE 3, 6, 9

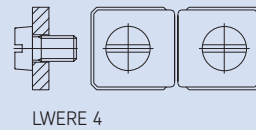

LWRE 4

### Special attachment screws

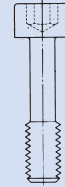

LWGD

														Crossed roller assemblies	End pieces	Special attachment screws	
225	250	275	300	350	400	450	500	550	600	650	700	800	900	1 000	LWAKE	LWRE	LWGD
○	○	○	○		○	○	○	○	○		○				●	●	●
	○		○		○	○	○	○	○		○				○	○	○
	■		■	○	■	○	○	○	○	○	○				●	●	●
			■		■		■		●		●	○	○	○	●	●	●
														Crossed roller assemblies	End pieces	Special attachment screws	
240	280	320	360	400											LWAKE	LWRE	LWGD
○	○	○	○	○											●	●	

- SKF Modular Range  
Preferred range, prompt delivery
- Prompt delivery
- To special order

Ordering example: 4 LWRE 90400  
2 LWAKE 9 x 22  
4 LWRE 9  
16 LWGD 9

# Accessories for LWRE rail guides

## Crossed roller assemblies

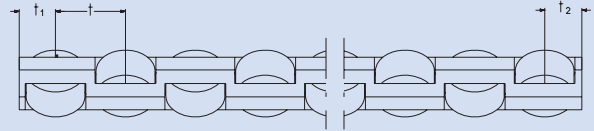
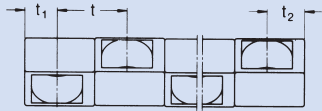
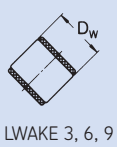

For description and data on crossed roller assemblies, please see page 21

Designation	Dimension				Load ratings for 10 needle rollers per row		Rail guide designation
	D <sub>w</sub>	t	t <sub>1</sub>	t <sub>2</sub>	dynamic C	static C <sub>0</sub>	
	mm				N		
LWAKE 3	4	6,25	2,65	3,6	6 300	8 500	LWRE 3, LWRE 2211
LWAKE 4	6,5	8	4,3	4,3	17 300	20 800	LWRE 4
LWAKE 6	8	11	5	6	34 000	39 000	LWRE 6
LWAKE 9	12	16	7,35	8,65	78 000	78 000	LWRE 9

## End pieces

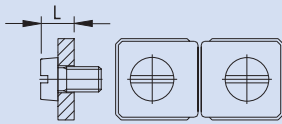
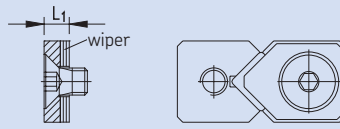
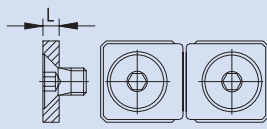

## Special attachment screws

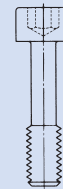

for designation and dimensions see page 19

Designation	Dimensions		Appropriate attachment screw	Rail guide designation
	without wiper	with wiper		
	L	L <sub>1</sub>		
	mm		DIN 7991	
LWERE 3		2	M 3	LWRE 3, LWRE 2211
	LWEREC 3	4	M 3	LWRE 3, LWRE 2211
LWERE 4		4	M 3 (DIN 84)	LWRE 4
LWERE 6		3	M 5	LWRE 6
	LWEREC 6	5	M 5	LWRE 6
LWERE 9		3	M 6	LWRE 9
	LWEREC 9	6	M 6	LWRE 9



# LWRE ACS rail guides with non-slip cage (Anti Creep System)



Many users are familiar with “cage-creep” in conventional precision rail guides. This effect occurs as a result of high acceleration and uneven pre-loading or load distribution. Thanks to a new design conceived by SKF Linersysteme GmbH, this drift of the cage away from its intended position is eliminated through a sophisticated “Anti Creep System”, in short ACS.

Precision rail guides with ACS increase the reliability of installations and lead to extended operating periods of the linear guides. Thus, damaged cages are a thing of the past.

Moreover, the exchange of guides and the resultant need for readjusting the machine or installation are eliminated.

**LWRE ACS rail guides** are equivalent to LWRE rail guides, designed for use in non-slip LWAKE cages.

The non-slip effect is achieved through a patented control gear attached to the cage which is in mesh between the LWRE ACS rails during operation, thus retaining the cage in its defined position.

The external dimensions of LWRE ACS rail guides are identical with those of LWRE rail guides. The non-slip guide has been integrated in the existing design. Thus, sizes LWRE 3 ACS, LWRE 6 ACS and LWRE 9 ACS fit into the Modular Range system. Sizes LWRE 4 ACS and LWRE 2211 ACS are available in addition. Split rail guides, rails of tolerance class P2 or P5 or protruding cages can be supplied upon request.

## Advantages

- ACS eliminates “cage-creep”
- Increased accuracy thanks to defined positioning of cage
- Easily interchangeable with standard precision rails
- Identical size thanks to integral design
- Suitable for high acceleration, vertical mounting and uneven load distribution
- Less downtime and lower maintenance requirements

“Cage-creep” test results

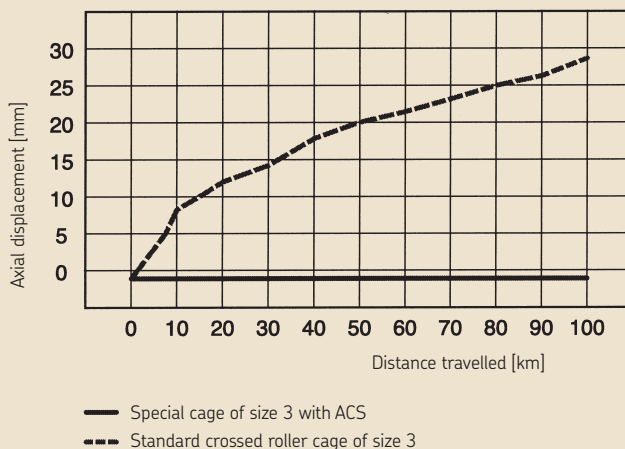

LWRE ACS rail guides can be designed for specified or maximum travel of the rail guide system. For systems with specified travel, the length of the stroke is quoted after the suffix ACS. LWAKE ACS cages must only be operated over the specified stroke length.

A rail guide with maximum travel is prepared for the use of ACS over its entire length. This may be required for mounting, maintenance or dismantling purposes. When placing an order, this design is specified by the suffix ACS, without a stroke, directly after the LWRE rail guide designation.

#### Ordering designation for LWRE ACS rail guides:

LWRE ACS rail guide for maximum travel of the rail system (see Fig. 11A):

LWRE rail ACS  
e.g. LWRE 6200 ACS

LWRE ACS rail guides for specified travel of the rail system (see Fig. 11B):

LWRE rail ACS stroke (mm)  
e.g. stroke: 100 mm  
(cage travel: 50 mm)  
LWRE 6200 ACS 100 mm

Because of the many permutations available, all parts of LWRE ACS rail guides are usually ordered separately, e.g.:

#### Maximum travel:

4 rails  
2 crossed roller cages  
8 end pieces

e.g.:

LWRE 6200 ACS  
LWAKE 6x12 ACS (147,3 mm)  
LWRE 6  
(see Fig. 11A)

#### Specified travel:

4 rails  
2 crossed roller cages  
8 end pieces

e.g.:

LWRE 6200 ACS 100 mm  
LWAKE 6x12 ACS (147,3 mm)  
LWRE 6  
(see Fig. 11B)

#### Ordering

To facilitate the order routine, rail guide sets can also be ordered in kit packaging (see pages 12 – 13).

Fig. 11 A

LWRE ACS rail guides for “maximum travel” stroke

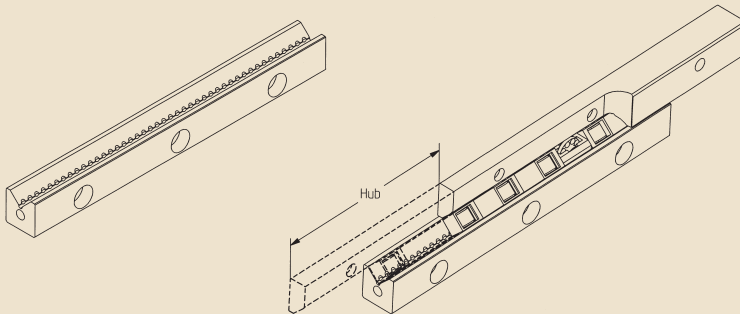
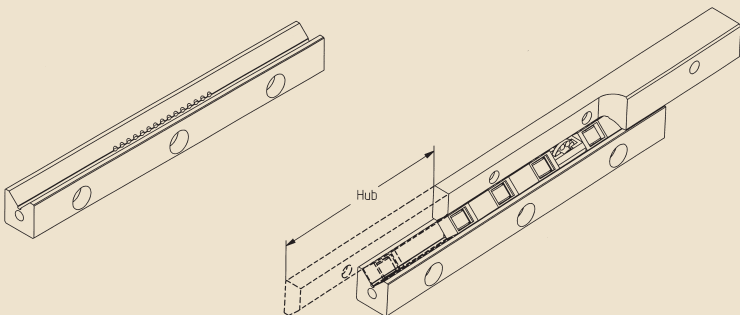

Fig. 11 B

LWRE ACS rail guides for “specified travel” stroke



### **Crossed roller assemblies for LWRE ACS rail guides**

Compared to LWAKE cages, LWAKE ACS crossed roller cages incorporate an additional control gear located at the centre of the cage. The load carrying capacity of LWAKE ACS cages is identical with that of LWAKE standard cages, provided that they comprise an identical number of rollers. However, it has to be taken into consideration that, due to their additional control gear, LWAKE ACS cages are longer than the corresponding LWAKE cages, even if the number of rollers is identical. Protruding cages should be used only after consultation with SKF.

### **Ordering designation for LWAKE ACS cages:**

LWAKE ACS cages should be ordered as follows:

LWAKE size x number of rollers ACS  
For instance, an LWAKE 6 cage with 12 rollers and ACS control gear has the designation LWAKE 6x12 ACS (147,3 mm).

### **End pieces for LWRE ACS rail guides**

As a rule, end pieces must not be used as a mechanical stroke limitation of the guidance system, as this can result in cage damage. End pieces can be used as a protection against external influences.

### **Special attachment screws for LWRE ACS rail guides**

For designation and dimensions, please refer to LWR, page 19. The listed special attachment screws of type LWGD can also be used for mounting LWRE ACS rail guides, if their respective size is taken into consideration.

### **Design and mounting of LWRE ACS rail guides**

Mounting of LWRE ACS rail guides proceeds to the same rules as mounting of SKF standard precision rails. In addition, it is essential to observe that the ACS control gear is constantly kept in mesh between the rails during operation. Furthermore, the cage must never be subjected to direct or indirect external axial loads. The ACS control gear must not be damaged during mounting, e.g. through the insertion of the ACS cage between the rails against an end stop, or tilting or twisting of two adjacent rails.

### **Protection and lubrication of LWRE ACS rail guides**

In order to ensure the impeccable operation of the Anti Creep System, it should be protected against contamination and relubricated with moderate quantities of SKF standard grease. Any "blocking" or "gumming" of the element must be ruled out.

# Accessories for LWRE ACS rail guides

## Crossed roller assemblies

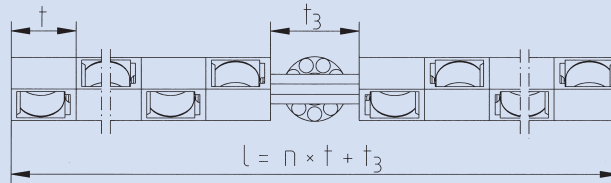
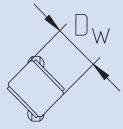

LWAKE 3, 6, 9 ACS

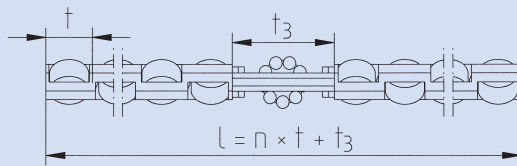
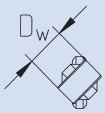

LWAKE 4 ACS

n = number of rollers

For description and data on crossed roller units, please see pages 21, 24 and 27.

Designation	Dimensions			Load ratings for 10 needlerollers per row		Rail guide designation
	$D_w$	t	$t_3$	dynamic C	static $C_0$	
	mm			N		
LWAKE 3 ACS	4	6,25	9	6 300	8 500	LWRE 3 ACS, LWRE 2211 ACS
LWAKE 4 ACS	6,5	8	17	17 300	20 800	LWRE 4 ACS
LWAKE 6 ACS	8	11	15,3	34 000	39 000	LWRE 6 ACS
LWAKE 9 ACS	12	16	22	78 000	78 000	LWRE 9 ACS

## End pieces

For designation and dimensions  
please see LWRE, page 24.

## Special attachment screws



LWGD

For designation and dimensions  
please see LWR, page 19.

# LWRM/LWRV rail guides

LWRM/LWRV rail guides offer guidance systems with high load carrying capacity and maximum stiffness.

## Needle roller assemblies for LWRM/LWRV rail guides

LWHW needle roller assemblies have aluminium cages with retained needle rollers. They are available for size 6 and 9 units.

When ordering, the appropriate cage length in mm should be stated after the cage designation, e.g.: LWHW 10x225.

## End pieces for LWRM/LWRV rail guides

End pieces serve to prevent the drift of the cage away from the loaded zone.

LWEARM and LWEARV end pieces feature a plastic wiper with a sealing lip that keeps the raceways free from contamination. All end pieces are supplied with the appropriate attachment screws.

The mounting and attachment dimensions of LWRM/LWRV rail guides conform to those of all the SKF Modular Range rail guides included in this catalogue.

Because of the many permutations available, each part of an LWRM/LWRV rail guide must be ordered separately, e.g.:

- 2 rails LWRM 90400
- 2 rails LWRV 90400
- 2 needle roller assemblies LWHW 15x358
- 2 end pieces LWEAM 9



# LWRM/LWRV rail guides

## LWRM/LWRV 6 and LWRM/LWRV 9

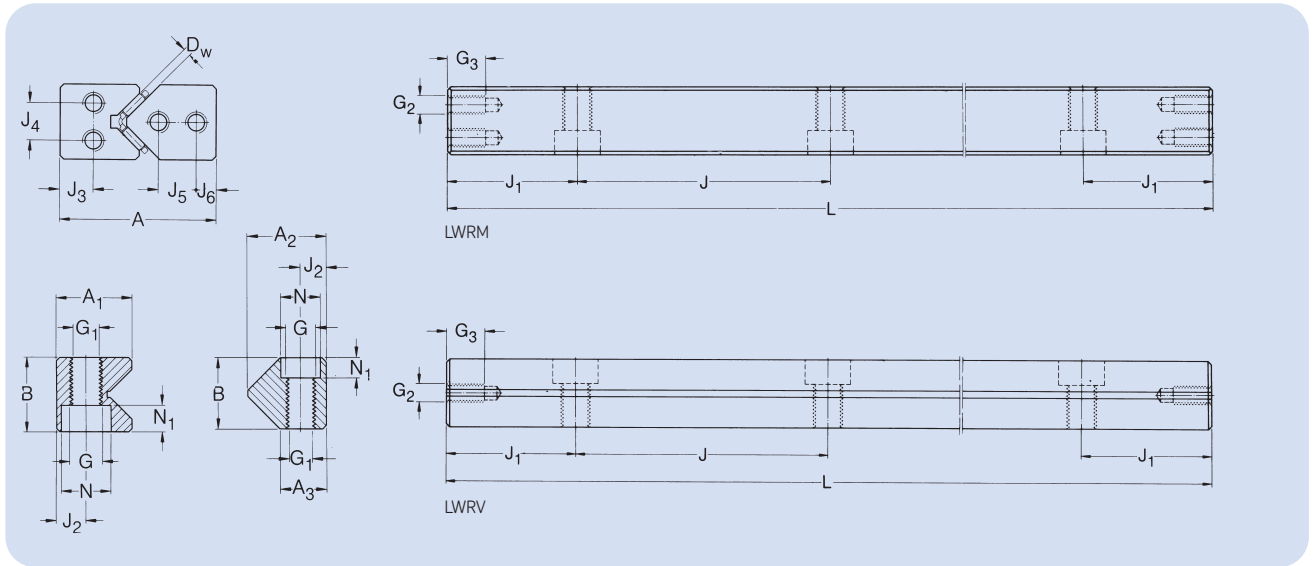

Designation <sup>1)</sup>	Dimensions: System					Attachment holes								End face holes					
	A	B	A <sub>1</sub>	A <sub>2</sub>	A <sub>3</sub>	D <sub>w</sub>	J	J <sub>1</sub>	J <sub>2</sub>	G	G <sub>1</sub>	N	N <sub>1</sub>	J <sub>3</sub>	J <sub>4</sub>	J <sub>5</sub>	J <sub>6</sub>	G <sub>2</sub>	G <sub>3</sub>
mm																			
LWRM 6	31	15	16,5	-	-	2	50	25	6	M 6	5,2	9,5	5,2	8,5	7	-	-	M 3	6
LWRV 6	31	15	-	17,8	10,8	2	50	25	6	M 6	5,2	9,5	5,2	-	-	7	6	M 3	6
LWRM 9	44	22	23,1	-	-	2	100	50	9	M 8	6,8	10,5	6,2	10	11	-	-	M 5	8
LWRV 9	44	22	-	26,9	16,6	2	100	50	9	M 8	6,8	10,5	6,2	-	-	10	6	M 5	8

<sup>1)</sup>Sizes LWRM/LWRV 12 and 15 as well as other rail lengths are available on request.

### Needle roller assemblies

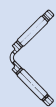

LWHW

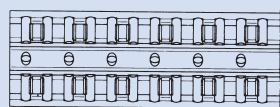

aluminium

### End pieces

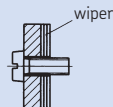

LWEARV  
with wiper

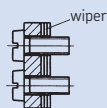
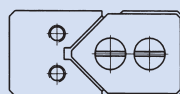

LWEARM  
with wiper

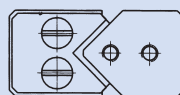

### Special attachment screw



LWGD

### Available lengths

L<sup>1)</sup>

Available lengths												Needle roller assemblies	End pieces		Special-attachment screws	
100	150	200	250	300	350	400	500	600	700	800	900	1 000	LWHW	LWEARM	LWEARV	LWGD
○	○	○	○	○	○	○	○	○	○				●	●	-	●
○	○	○	○	○	○	○	○	○	○				●	-	●	●
		○		○		○	○	○	○	○	○	○	●	●	-	●
		○		○		○	○	○	○	○	○	○	●	-	●	●

- SKF Modular Range  
Preferred range, prompt delivery
- Prompt delivery
- To special order

Ordering example: 2 LWRM 90600  
2 LWRV 90600  
2 LWHW 15 x 450  
4 LWEARM 9

# Accessories for LWRM/LWRV rail guides

## Needle roller assemblies

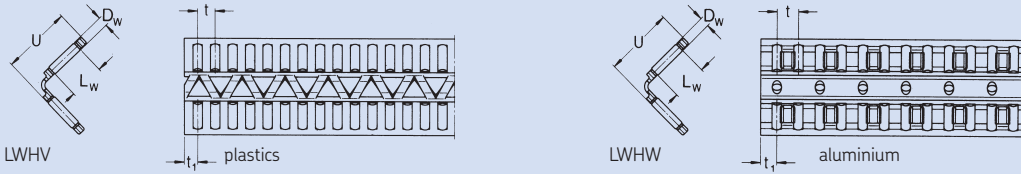

For description and data on needle roller assemblies, please see page 29

Designation	Dimensions					Load ratings for 10 needle rollers per row		Rail guide designation
	$D_w$	$L_w$	U	t	$t_1$	dynamic C	static $C_0$	
	mm					N		
LWHV 10	2	4,8	10	3,75	2,7	10 400	25 500	LWRM 6/LWRV 6
LWHW 10	2	4,8	10	3,75	2,7	10 400	25 500	LWRM 6/LWRV 6
LWHV 15	2	7,8	15	3,75	2,7	16 300	45 000	LWRM 9/LWRV 9
LWHW 15*	2	6,8	15	4,5	3,5	14 600	42 500	LWRM 9/LWRV 9

## End pieces

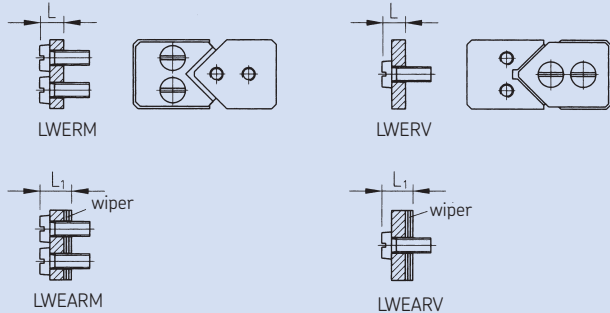

## Special attachment screw

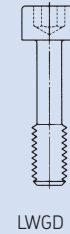

for designation and dimensions see page 19

Designation	Dimensions		Appropriate attachment screws	Rail guide designation	
	without wiper	with wiper			
	L	$L_1$			
	mm				
LWERM 6	4		M 3	DIN 84	LWRM 6
LWERV 6	4		M 3	DIN 84	LWRV 6
		6	M 3	DIN 84	LWRM 6
		6	M 3	DIN 84	LWRV 6
LWERM 9	6,3		M 5	DIN 84	LWRM 9
LWERV 9	6,3		M 5	DIN 84	LWRV 9
		8,3	M 5	DIN 84	LWRM 9
		8,3	M 5	DIN 84	LWRV 9

\* Higher load ratings are available on request



# LWRPM/LWRPV rail guides

LWRPM/LWRPV rail guides are linear guides for limited travel, fitted with Turcite-B®<sup>1)</sup> slide coating.

Based on PTFE, this material is self-lubricating and offers excellent sliding properties.

The coating is bonded to the non-hardened LWRPM rail and subsequently ground to size. The LWRPV rail is hardened and ground. In order to avoid damage to the sliding surface of the LWRPM rail, the leading edges of the LWRPV rails are slightly rounded. Otherwise, the dimensions of these rails are the same as those of the LWRV series.

LWRPM/LWRPV rail guides should be used where rail guides with rolling element assemblies are unsuitable due to external influences.

Such applications include those subjected to high transverse acceleration that may cause indentation of the rolling elements in the raceways, or where extremely short strokes are required. The unfavourable tribological conditions produced by such operation would give rise to race-way pitting in a rolling element rail guide.

The mounting and attachment dimensions of the LWRPM/LWRPV rail guides conform to those of all the SKF Modular Range rail guides included in this catalogue.

LWRPM/LWRPV rail guides are characterised by:

- stick-slip-free operation
- smooth running
- good emergency running properties
- low wear and high reliability
- insensitivity to contamination
- excellent vibration damping properties

When ordering, the individual components of the rail guides must be specified separately, e.g.:

2 rails LWRPM 6300

2 rails LWRPV 6300

<sup>1)</sup>Turcite-B® is a registered trademark of Busak & Shamban GmbH



# LWRPM/LWRPV rail guides

## LWRPM/LWRPV 3 – LWRPM/LWRPV 9

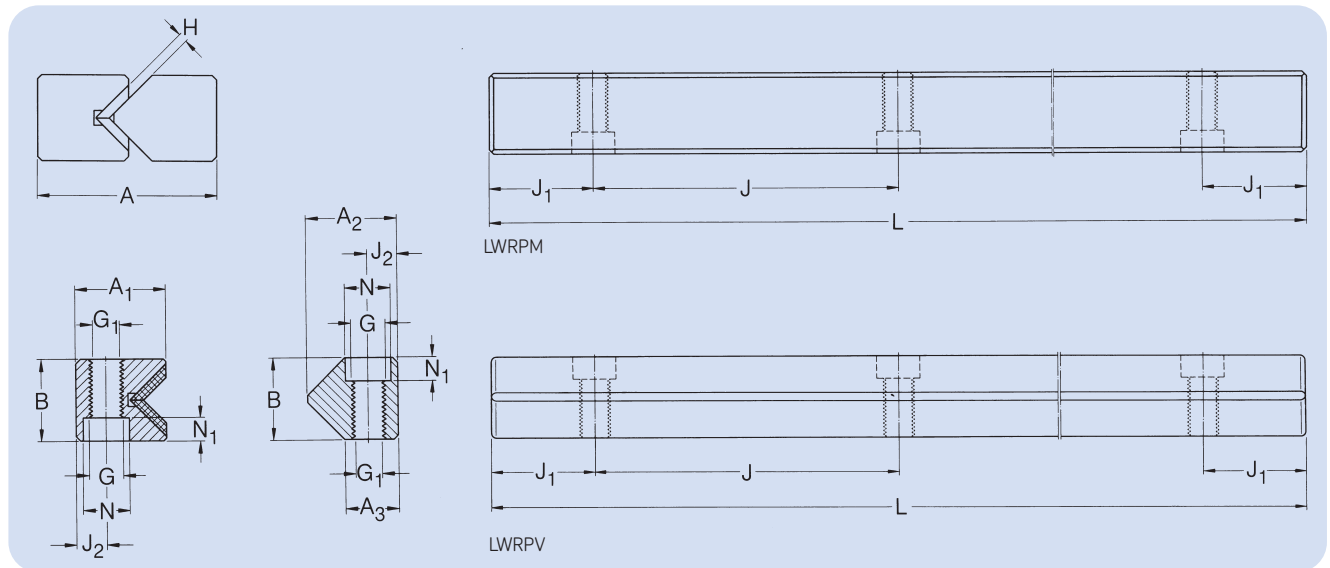

Designation <sup>1)</sup>	Dimensions: System					Attachment holes						
	A	B	A <sub>1</sub>	A <sub>2</sub>	A <sub>3</sub>	J	J <sub>1</sub>	J <sub>2</sub>	G	G <sub>1</sub>	N	N <sub>1</sub>
	mm											
LWRPM 3	18	8	9,5	–	–	25	12,5	3,5	M 4	3,3	6	3,2
LWRPV 3	18	8	–	9,6	6,45	25	12,5	3,5	M 4	3,3	6	3,2
LWRPM 6	31	15	16,6	–	–	50	25	6	M 6	5,2	9,5	5,2
LWRPV 6	31	15	–	17,8	10,8	50	25	6	M 6	5,2	9,5	5,2
LWRPM 9	44	22	23,1	–	–	100	50	9	M 8	6,8	10,5	6,2
LWRPV 9	44	22	–	26,9	16,6	100	50	9	M 8	6,8	10,5	6,2

<sup>1)</sup> Sizes LWRPM/LWRPV 12 and LWRPM/LWRPV 15 as well as other rail lengths are available on request.

### Slide coating

LWRPM rail guides are provided with a slide coating bonded to the raceways and subsequently ground to size. Separate ordering of the slide coating is not required.

### End pieces

Because of their design, rail guides of these series do not normally require the use of end pieces.

### Special attachment screws

For designations and dimensions, see page 19.

Available lengths

L<sup>1)</sup>

050	075	100	125	150	175	200	225	250	275	300	350	400	450	500	550	600	650	700	800	900	1 000	LWGD	
o	o	o	o	o	o	o	o	o	o	o													•
o	o	o	o	o	o	o	o	o	o	o													•
		o		o		o		o		o	o	o	o	o	o	o	o	o					•
		o		o		o		o		o	o	o	o	o	o	o	o	o					•
						o				o	o	o	o	o	o	o	o	o	o	o	o	o	•
						o				o	o	o	o	o	o	o	o	o	o	o	o	o	•

Special attachment screws

- SKF Modular Range Preferred range, prompt delivery
- Prompt delivery
- o To special order

Ordering example: 2 LWRPM 6400  
2 LWRPV 6300

# Accessories for LWRPM/LWRPV rail guides

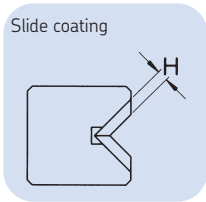

Designation <sup>1)</sup>	Dimensions	load carrying capacity <sup>2)</sup>	Rail guide designation
Rail guide	H	C	
	mm	N	
LWRPM 3	0,7	300/100 mm	LWRPV 3
LWRPM 6	1,7	700/100 mm	LWRPV 6
LWRPM 9	1,7	1 200/100 mm	LWRPV 9

<sup>1)</sup> The slide coating is an integral part of the LWRPM rail and does not have to be ordered separately.

<sup>2)</sup> for a surface loading of approx. 1 N/mm<sup>2</sup> (momentary loads of up to 6 N/mm<sup>2</sup> are permissible).

## End pieces

LWRPM/LWRPV rail guides, by virtue of their design, do not normally require end pieces.

For this reason, tapped holes on the end faces are also unnecessary.

However, for production reasons, LWRPV rail guides will in certain cases be supplied with end face holes.

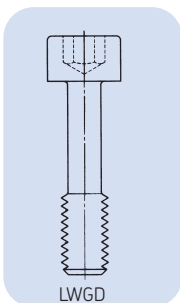

## Special attachment screws

See page 19 for designations and dimensions.

# LWM/LWV rail guides

LWM/LWV rail guides enable the design of linear guidance systems for heavy loads with maximum stiffness.

The internal geometry is identical with that of the Modular Range rails of the LWRM/LWRV series. As the same needle roller assembly is used, the load ratings are also the same. The external dimensions of the LWM/ LWV rail guides, however, differ slightly from those of the LWRM/LWRV Modular Range dimensions.

Yet LWM/LWV rail guides find wide application especially in machine tools. As standard they are supplied with attachment holes of type 15, i.e. through hole with counterbore.

If attachment hole type 13 is ordered, corresponding threaded inserts are supplied along with the guide.

For new designs the choice of LWRM/LWRV rail guides is recommended. These offer the advantage of being interchangeable with other rail guides of the Modular Range.

## Needle roller assemblies for LWM/LWV rail guides

LWHW needle roller assemblies comprise an aluminium cage with needle rollers arranged at right angles to each other. The needle rollers are retained by the cage.

## End pieces for LWM/LWV rail guides

End pieces serve to prevent drift of the cage away from the loaded zone.

LWEAM and LWEAV end pieces have the addition of a plastic wiper with a sealing lip that keeps the raceway free from dirt.

**All end pieces are supplied together with attachment screws.**

Rail guides with a length of more than 1 200 mm should be made up of sections. If, for design reasons, one-piece rails are required, these can be supplied to special order.



# LWM/LWV rail guides

## LWM/LWV 3015 – LWM/LWV 8050

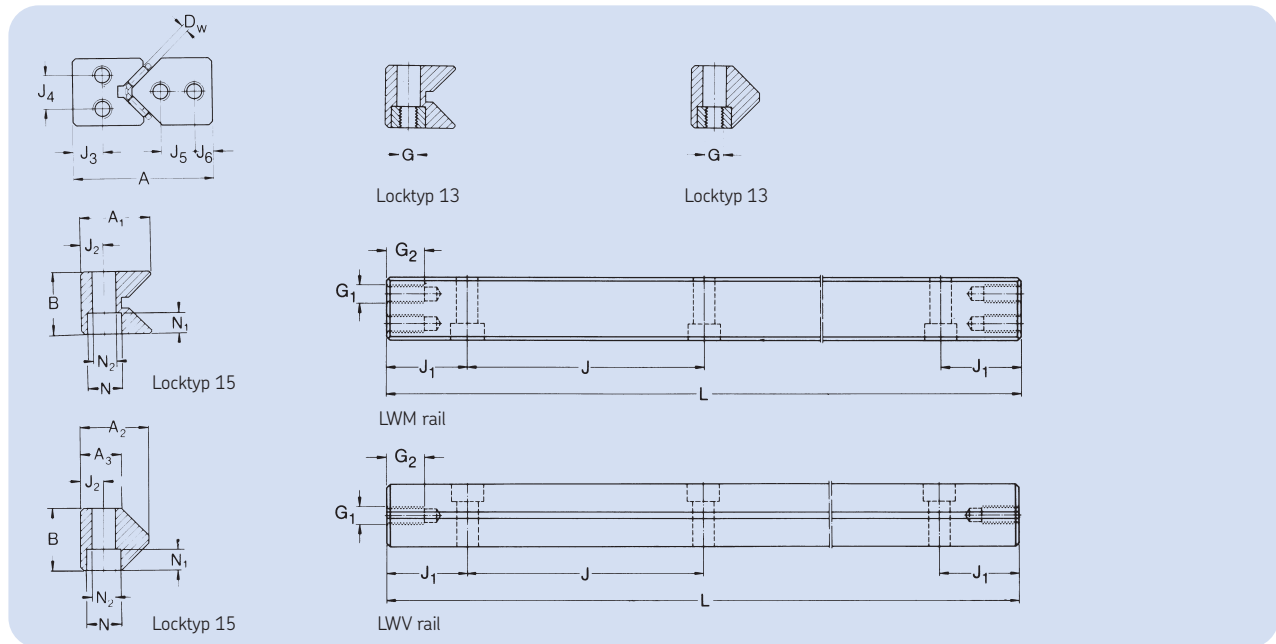

Designation	Dimensions: Systems						Attachment holes						End face holes						
	A	B	A <sub>1</sub>	A <sub>2</sub>	A <sub>3</sub>	D <sub>w</sub>	J <sup>1)</sup>	J <sub>1min</sub> <sup>2)</sup>	J <sub>2</sub>	G	N	N <sub>1</sub>	N <sub>2</sub>	J <sub>3</sub>	J <sub>4</sub>	J <sub>5</sub>	J <sub>6</sub>	G <sub>1</sub>	G <sub>2</sub>
mm																			
LWM 3015	30	15	16	–	–	2	40	15	5,5	M 4	8,5	4,5	5,25	8	7	–	–	M 3	6
LWV 3015	30	15	–	17,2	10,5	2	40	15	5,5	M 4	8,5	4,5	5,25	–	–	7	5,5	M 3	6
LWM 4020	40	20	22,3	–	–	2	80	15	7,5	M 6	11,5	6,8	7,5	10	11	–	–	M 5	7
LWV 4020	40	20	–	22	13,5	2	80	15	7,5	M 6	11,5	6,8	7,5	–	–	10,5	5,5	M 5	7
LWM 5025	50	25	28	–	–	2	80	20	10	M 6	11,5	6,8	7,5	12	13	–	–	M 6	8
LWV 5025	50	25	–	28	17	2	80	20	10	M 6	11,5	6,8	7,5	–	–	13	7	M 6	8
LWM 6035	60	35	36	–	–	2,5	100	20	11	M 8	15	9	10	14	20	–	–	M 6	8
LWV 6035	60	35	–	36	20	2,5	100	20	11	M 8	15	9	10	–	–	18	8	M 6	8
LWM 7040	70	40	40	–	–	3	100	20	13	M 10	18,5	11	12,5	16	20	–	–	M 6	8
LWV 7040	70	40	–	42	24	3	100	20	13	M 10	18,5	11	12,5	–	–	20	10	M 6	8
LWM 8050	80	50	45	–	–	3,5	100	20	14	M 12	20	13	14	20	30	–	–	M 6	8
LWV 8050	80	50	–	48,5	26	3,5	100	20	14	M 12	20	13	14	–	–	25	10	M 6	8

<sup>1)</sup> for lengths  $L < J + 2 \cdot J_{1min}$ ,  $J = 50$  mm (except for LWM/LWV 3015)

<sup>2)</sup>  $J_1$  depends upon the rail length and is of the same size at each end of the rail

$$J_1 = \frac{L - \sum J}{2}$$

<sup>3)</sup>  $J = 35$  mm

### Needle roller assemblies

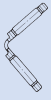

LWHW

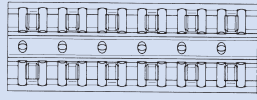

aluminium

### End pieces

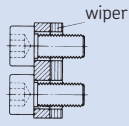

LWEAM  
with wiper

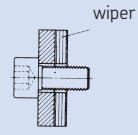
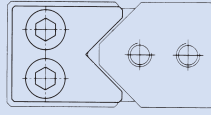

LWEAV  
with wiper

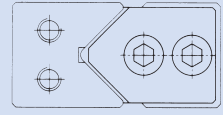

### Available lengths<sup>4)</sup>

100	150	200	300	400	500	600	700	800	900	1 000
● <sup>3)</sup>	●	●	●	●	○	○				
● <sup>3)</sup>	●	●	●	●	○	○				
●	●	●	●	●	○	○	○	○	○	○
●	●	●	●	●	○	○	○	○	○	○
●	●	●	●	●	○	○	○	○	○	○
		○	○	○	○	○	○	○	○	○
		○	○	○	○	○	○	○	○	○
		○	○	○	○	○	○	○	○	○
		○	○	○	○	○	○	○	○	○
		○	○	○	○	○	○	○	○	○
		○	○	○	○	○	○	○	○	○

### Needle roller assemblies

LWHW

### End pieces

LWEA

LWEAV

<sup>4)</sup> other lengths available on request

- available from stock
- available to order

Ordering example: 2 LWM 4020200  
 2 LWV 4020200  
 2 LWHW 15x130  
 4 LWEAM 4020

# Accessories for LWM/LWV rail guides

## Needle roller assemblies

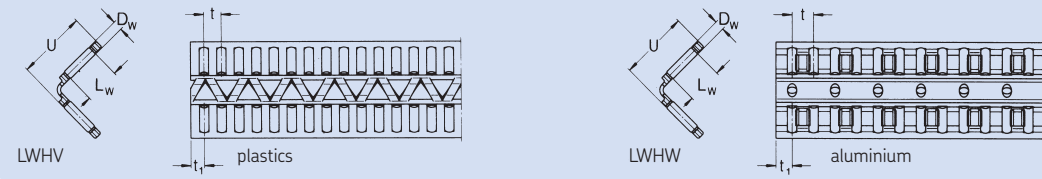

For description and data on crossed roller assemblies, please see page 37.

Designation	Dimensions					Load ratings for 10 needle rollers per row		Rail guide designation
	$D_w$	$L_w$	U	t	$t_1$	dynamic C	static $C_0$	
	mm	N						
LWHW 10	2	4,8	10	3,75	2,7	10 400	25 500	LWM/LWV 3015
LWHV 15	2	7,8	15	3,75	2,7	16 300	45 000	LWM/LWV 4020 + 5025
LWHW 15*	2	6,8	15	4,5	3,5	14 600	42 500	LWM/LWV 4020 + 5025
LWHV 20	2,5	11,8	20	5	3,7	32 000	88 000	LWM/LWV 6035
LWHW 20*	2,5	9,8	20	5,5	4,0	26 000	76 550	LWM/LWV 6035
LWHW 25*	3	13,8	25	6	4,5	43 100	129 400	LWM/LWV 7040
LWHW 30*	3,5	17,8	30	7	5,0	64 500	195 000	LWM/LWV 8050

## End pieces

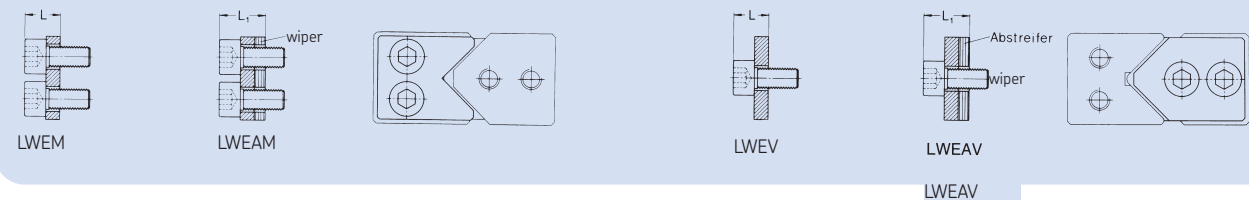

Designation	Dimensions		Appropriate attachment screws
	without wiper	with wiper	
	L	$L_1$	
	mm		
LWEM 3015	4		M 3 DIN 84
LWEV 3015	4		M 3 DIN 84
		6	M 3 DIN 84
		6	M 3 DIN 84
LWEM 4020	6,3		M 5 DIN 84
LWEV 4020	6,3		M 5 DIN 84
		8,3	M 5 DIN 84
		8,3	M 5 DIN 84
LWEM/LWEV 5025 bis 8050	6,9		M 6 DIN 84
		8,9	M 6 DIN 84

\* Higher load ratings are available on request



## LWJ/LWS flat rail guides

LWJ/LWS flat rail guides are used in conjunction with LWRM/LWRV, LWM/LWV or LWN/LWO rail guides as non-locating linear guides. They are incorporated in floating slides.

LWJ/LWS flat rail guides as well as the appropriate rolling element assemblies and end pieces are available to order.



# LZM miniature slides



With the new LZM miniature slide product range SKF offers the ideal solution for linear motion applications for short strokes and compact boundary dimensions. The use of miniature slides has increased in medical applications, measurement technologies and micro mechanics & assembly.

The different LZM miniature slide components meet the highest precision standards. LZM miniature slides feature high running accuracy and smooth motion.

The LZM miniature slides are manufactured with all stainless steel components. Optimized hardness enables long endurance life and high performance within compact boundary dimensions.

The new LZM miniature slides have been designed to ensure high system stiffness and precision guidance.

Running accuracies of 2  $\mu\text{m}$  over a stroke of 100 mm are attainable depending on the particular application. Ease of installation is another advantage of the LZM miniature slides. Unlike cross roller systems using 4 rails and cages to be assembled on the production floor, the LZM slide provides a complete slide that can simply be bolted into place without the use of precision devices to set preload.

Every application provides new challenges for the modern designer. SKF will modify existing designs to meet your specific technical requirements.

## Applications:

- Pneumatics
- Semi conductor manufacturing
- Medical
- Micro- and electronics assembly
- Measurement applications
- Fiber optics

## Advantages:

- Compact design
- High carrying capacity
- Very good running accuracy
- Smooth running
- High stiffness
- Easy assembly

## Technical data

Structure	Four-point contact with identical load angles
Range	Four (4) sizes (7, 9, 12 and 15)
Temperature resistance	From -20 °C up to +80 °C
Speed	Up to 3 m/s
Acceleration	Up to 80 m/s <sup>2</sup> (preloaded system)
Preload class	Three (3) preload classes (T0, T1 and T2) T0 = standard, light clearance T1 = light preload, very slight clearance T2 = medium preload, no clearance
Accuracy class	Two (2) accuracy classes (P1 and P5) P1 = high P5 = standard, for most applications
Lubrication	Slides are pre-lubricated with "Paraliq P460"

## Material specifications

Carriage & rail	Steel 1.4034
Balls	Steel 1.4034
End piece	Plastic
Cage	Plastic

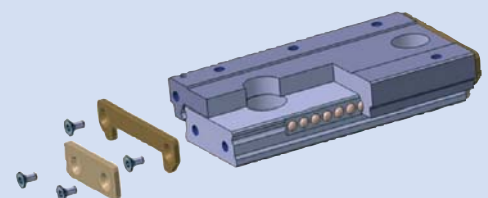

# LZM miniature slide

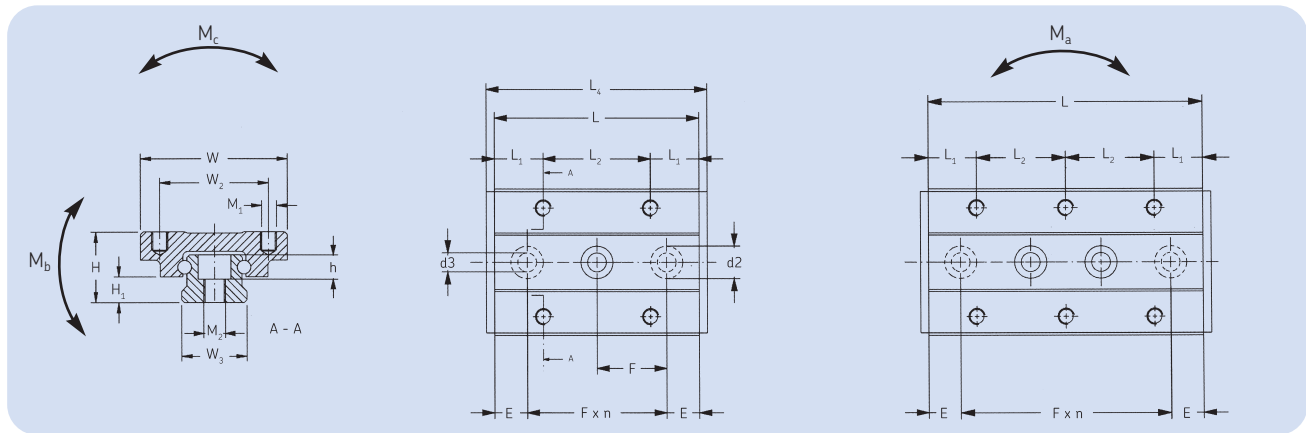

Type	W	W <sub>2</sub>	W <sub>3</sub>	L <sub>2</sub>	M <sub>1</sub> x depth	d <sub>3</sub> x d <sub>2</sub> x h	H	H <sub>1</sub>	M <sub>2</sub>	F
mm										
LZM HS 7	17	12	7	8	M2 x 2,5	2,5 x 4,5 x 2,5	8	2,35	M3	15
LZM HS 9	20	15	9	13	M3 x 3	3,5 x 6,0 x 3,5	10	3,55	M4	20
LZM HS 12	27	20	12	15	M3 x 3,5	3,5 x 6,0 x 4,5	13	4,7	M4	25
LZM HS 15	32	25	15	20	M3 x 4	3,5 x 6,0 x 4,5	16	6	M4	40

Type	L	L <sub>4</sub>	E	L <sub>1</sub>	max. stroke	Number of holes carriage rail		C	C <sub>0</sub>	Ma/Mb	Mc
mm											
-											
N											
Nm											
LZM HS 7	26	29	5,5	5	24	6	2	700	1 100	3,5	6
	34	37	9,5	5	34	8	2	900	1 400	5,5	7
	50	53	10	5	50	12	3	1 100	2 000	12	10
	66	69	10,5	5	66	16	4	1 400	2 700	21	14
LZM HS 9	32	35	8	9,5	28	4	2	1 200	1 800	7	12
	42	45	11	8	40	6	2	1 400	2 100	11	15
	55	58	7,5	8	54	8	3	1 900	3 400	18	19
	81	84	10,5	8	78	12	4	2 500	4 900	43	29
	94	97	7	8	92	14	5	2 700	5 500	57	33
LZM HS 12	37	40	6	11	32	4	2	2 200	3 300	11	21
	51	54	13	10,5	47	6	2	2 600	4 300	22	28
	66	69	8	10,5	62	8	3	3 000	5 300	36	36
	96	99	10,5	10,5	95	12	4	3 800	7 200	76	52
	126	129	13	10,5	122	16	6	4 700	9 700	131	68
LZM HS 15	52	56	6	12,5	50	4	2	2 800	3 900	25	42
	85	89	22,5	12,5	80	8	2	4 600	7 800	73	70
	105	109	12,5	12,5	102	10	3	5 100	9 100	106	84
	165	169	22,5	12,5	162	16	4	7 300	15 000	264	131

Order example:      Miniatur slide unit      Standard      Size      Length (L)  
 LZM      HS      9      -      32

# Standard slides

## Design and characteristic features

### General

The range of slides shown in this catalogue is standardised in terms of design, sizes and type of bearing. Slides differing from those included here, in design and drill hole pattern can only be produced economically in large batches.

### GCL standard slides

Slide top and base of blackened steel or GG25 (cast iron) depending on size.

These slides are provided with standard patterns of mounting holes. The slide top carries tapped holes and the base plate counterbored holes to DIN 74 Form K for cylindrical screws to DIN 912. Both the upper and lower surfaces of the slides are

ground. The surface of the side opposite to the set screws is ground parallel to the slide axis and can therefore be used as a reference face. Internal stops serve as stroke limits. The slides are fitted with SKF precision rail guides type LWR with cross roller cage assemblies type LWAK (plastic) for GCL 3 or type LWAL (aluminium) for GCL 6. The mounting orientation is optional.



# Technical data

## Tolerances

Slide straightness: height Tz  
side Ty

## GCL and RM standard slides

Tolerance (P10)	Stroke [mm]						
	25	50	100	200	300	400	500
	μm						
Straightness: height Tz	2	2	3	3	4	4	5
Straightness: side Ty	2	2	2	3	3	4	4

### Specific features

The standard slides are fitted with limited-stroke rail guides, with cross roller units.

### Permissible speed and acceleration

The rail guides can run at speeds up to **2 m/s** and accelerations up to **10 m/s<sup>2</sup>** are acceptable.

### Preload

Preload is applied by set screws fitted along one side of the slide top. The standard slides are preloaded to approximately 10 % of the static load rating.

### Materials

GCL Standard slides

- slide top and base: blackened steel or GG25 (cast iron), depending on size

For all slides

- guide rails: tool steel 90MnCrV9 (1.2842) hardened
- rolling elements: carbon chromium steel 100Cr6 (1.3505) hardened
- cage: plastic PA12 or aluminium, depending on size

### Permissible operating temperature

-30 °C to +80 °C

### Friction

The slides are free from stickslip. With normal light lubrication they have a coefficient of friction of between 0,003 and 0,005.

### Lubrication

Rail guides of standard slides are lightly greased on assembly with SKF LGMT2 grease, a multi-purpose lithium based grease which also serves as protection against corrosion. It can be used in all standard applications.

# Standard slides

## GCL - Drill hole pattern in top plate

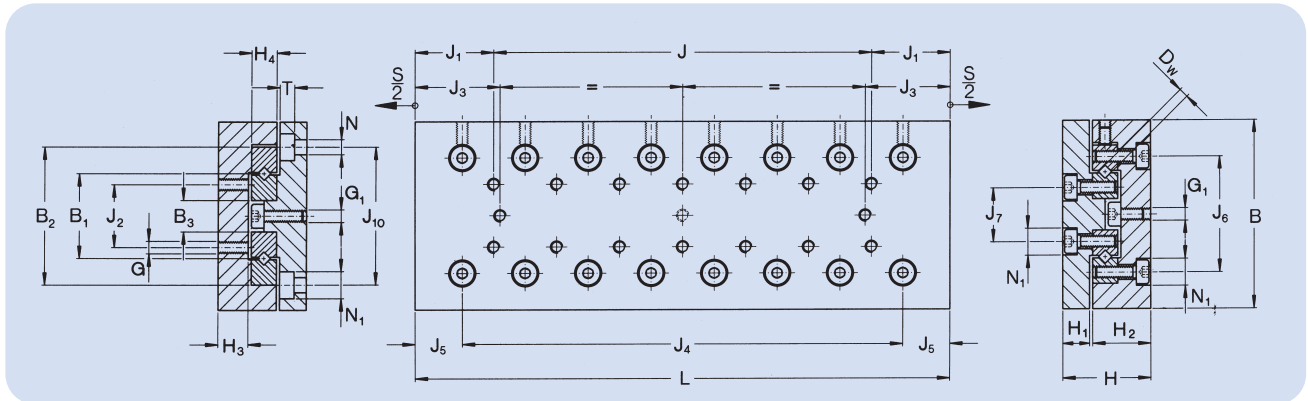

Designations	Dimensions			Stroke S	Stroke												
	B -0,2 -0,4	H ±0,1	L		B <sub>1</sub>	B <sub>2</sub>	B <sub>3</sub>	D <sub>w</sub>	G	G <sub>1</sub>	H <sub>1</sub>	H <sub>2</sub>	H <sub>3</sub>	H <sub>4</sub>	J	J <sub>1</sub>	J <sub>2</sub>
mm																	
GCL 3050	60	28	55	30	28	46	10	3	M4	M4	9	18,5	10	8	-	27,5	25
GCL 3075			80	45											1x25		
GCL 3100			105	60											2x25		
GCL 3125			130	75											3x25		
GCL 3150			155	90											4x25		
GCL 3175			180	105											5x25		
GCL 3200			205	130											6x25		
GCL 6100	100	45	110	60	45	76	14	6	M6	M5	13	31	15,5	15	-	55	50
GCL 6150			160	95											1x50		
GCL 6200			210	130											2x50		
GCL 6250			260	165											3x50		
GCL 6300			310	200											4x50		
GCL 6400			410	280											6x50		

# Standard slides

## GCL - Drill hole pattern in base plate

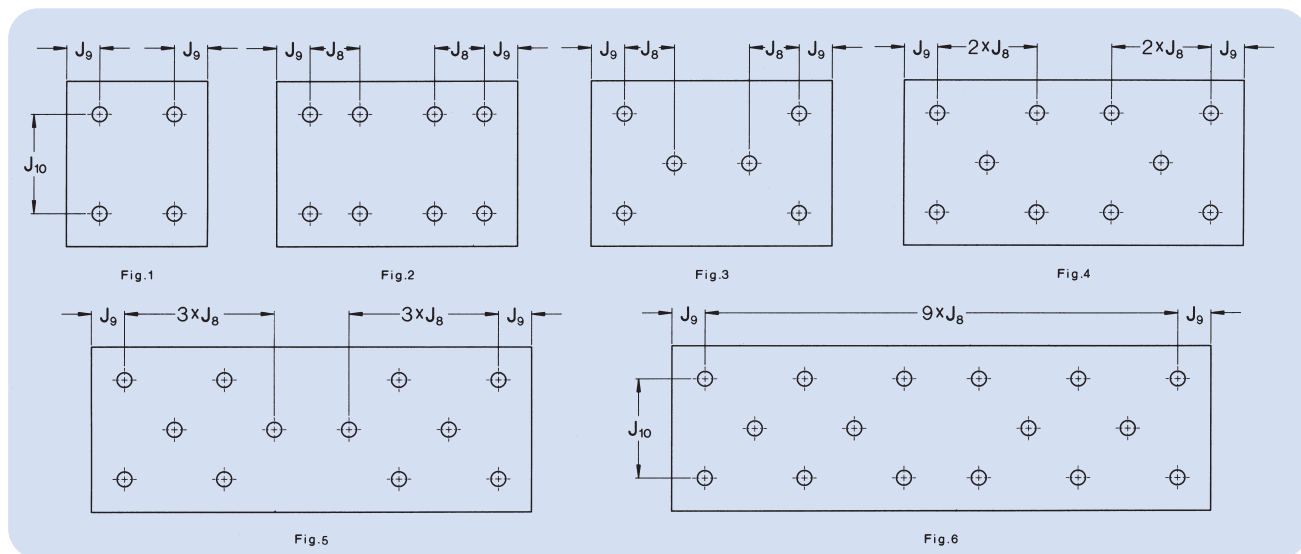

$J_3$	$J_4$	$J_5$	$J_6$	$J_7$	$J_8$	$J_9$	$J_{10}$	Fig	N	$N_1$	T	Load carrying capacity		Mass
												$C_{eff}$	$C_0$	
5,5	1x25	15	39	17	25	10	40	1	4,5	8	4,6	1 030	480	0,57
10,5	2x25							1				1 535	800	0,80
15,5	3x25							1				1 883	1 040	1,0
20,5	4x25							1				2 322	1 360	1,3
25,5	5x25							3				2 636	1 600	1,5
30,5	6x25							3				3 038	1 920	1,7
30,5	7x25							4				3 234	2 080	2,0
16	1x50	30	64	26	50	10	60	1	6,6	11	6,8	5 150	2 380	3,1
23,5	2x50							1				7 327	3 740	4,5
31	3x50							3				8 844	4 760	5,9
38,5	4x50							3				10 759	6 120	7,2
46	5x50							3				12 134	7 140	8,6
56	7x50							4				15 186	9 520	11,4

# Notes





# Notes

A large grid of graph paper, consisting of 20 columns and 30 rows of small squares, intended for taking notes.

# Notes

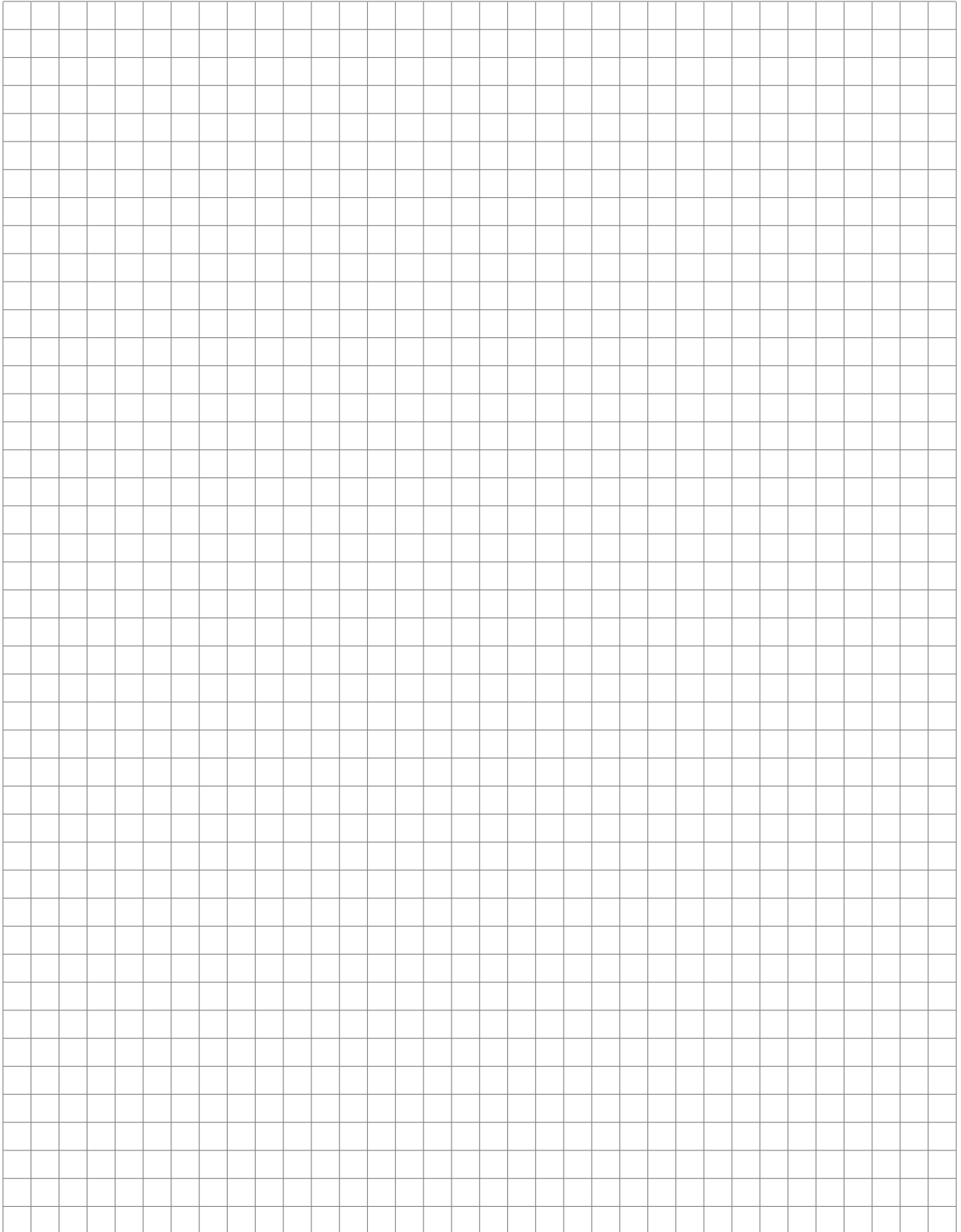

# Notes

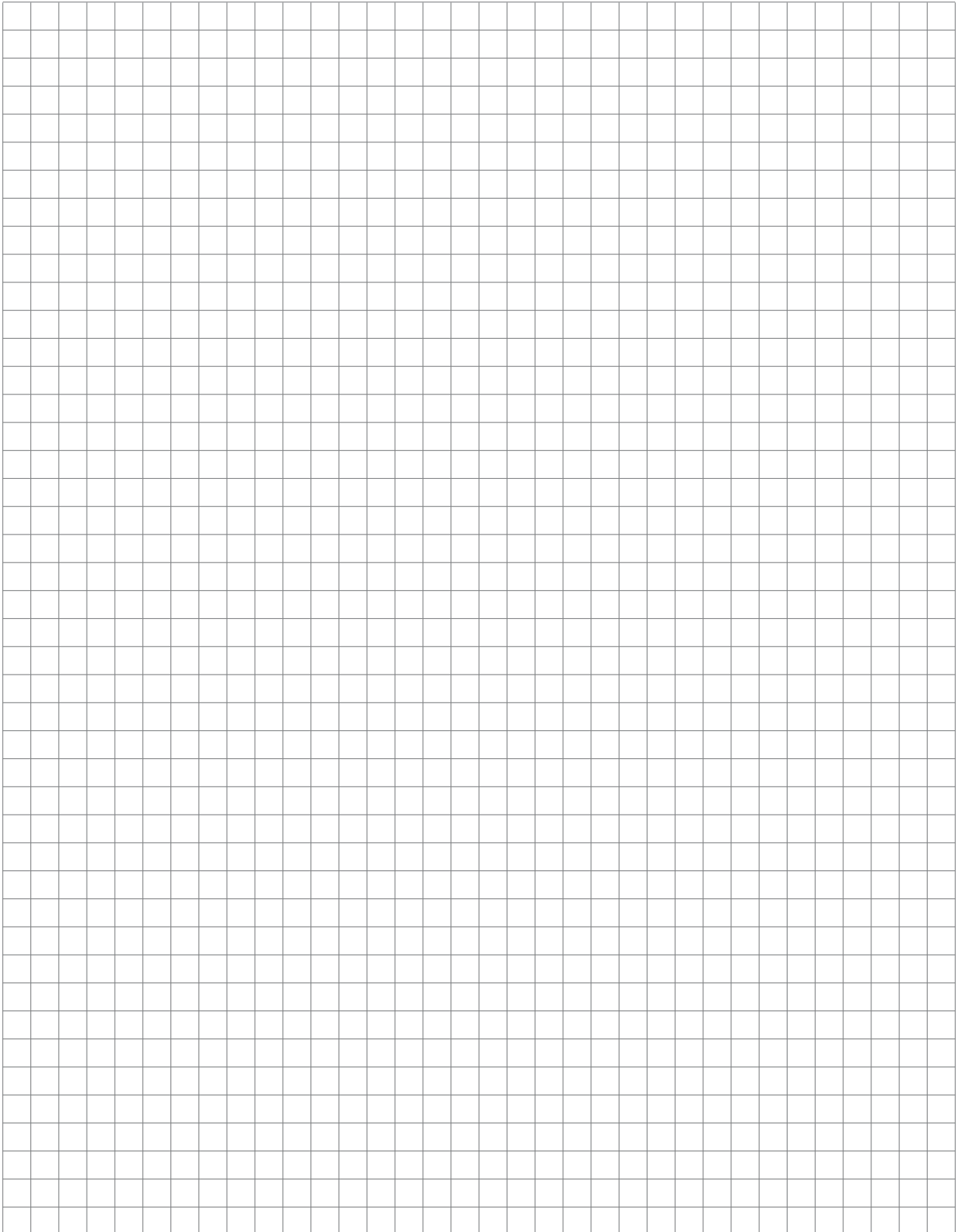

# Contacts

Linear motion from SKF  
[www.linearmotion.skf.com](http://www.linearmotion.skf.com)

## Benelux

### SKF Multitec Benelux B.V.

Nederland

Tel +31 030 6029 029

Fax +31 030 6029 028

België & Luxembourg

Tel +32 25 024 270

Fax +32 25 027 336

E-mail [multitec\\_benelux@skf.com](mailto:multitec_benelux@skf.com)

## Brasil

### SKF do Brasil Ltda

Tel +55 11 461 991 114

Fax +55 11 461 991 99

E-mail [marketing.skf@skf.com.br](mailto:marketing.skf@skf.com.br)

## Canada

### SKF Canada Limited

Tel +1 416 299 1220

Fax +1 416 299 6548

E-mail [www.marketing@skf.ca](http://www.marketing@skf.ca)

## Danmark

### SKF Multitec

Tel +45 65 92 77 77

Fax +45 65 92 74 77

E-mail [customerservice.multitec@skf.com](mailto:customerservice.multitec@skf.com)

## Deutschland & Österreich

### SKF Linearsysteme GmbH

Tel +49 9721 657 232/233

Fax +49 9721 657 111

E-mail [lin.sales@skf.com](mailto:lin.sales@skf.com)

## España & Portugal

### SKF Productos Industriales S.A.

Tel +34 93 377 99 07/-77

Fax +34 93 474 2039/-2156

E-mail [prod.ind@skf.com](mailto:prod.ind@skf.com)

## France

### SKF Equipements

Tel +33 1 30 12 73 00

Fax +33 1 30 12 69 09

E-mail [equipements.france@skf.com](mailto:equipements.france@skf.com)

## Italia

### SKF Multitec S.p.A.

Tel +39 011 22 49 01

Fax +39 011 22 49 233

E-mail [multitec.italy@skf.com](mailto:multitec.italy@skf.com)

## Mexico

### SKF de México S.A. de C.V

Tel +52 222 229 4900

Fax +52 222 229 4908

Web [www.skf.com.mx](http://www.skf.com.mx)

## Norge

### SKF Multitec

Tel +47 22 90 50 00

Fax +47 22 30 28 14

E-mail [customerservice.multitec@skf.com](mailto:customerservice.multitec@skf.com)

## Schweiz

### SKF LM&PT

Tel +41 44 825 81 81

Fax +41 44 825 82 82

E-mail [skf.schweiz@skf.com](mailto:skf.schweiz@skf.com)

## Suomi

### SKF Multitec

Tel +358 9 615 00 850

Fax +358 9 615 00 851

E-mail [multitec.nordic@skf.com](mailto:multitec.nordic@skf.com)

## Sverige

### SKF Multitec

Tel +46 42 253 500

Fax +46 42 253 545

E-mail [customerservice.multitec@skf.com](mailto:customerservice.multitec@skf.com)

## Linear guidings

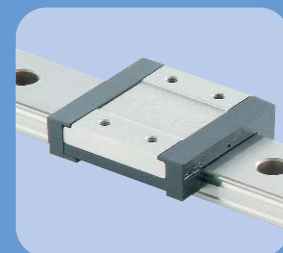

## U.K.

### SKF (UK) Ltd.

Tel +44 1582 496 735

Fax +44 1582 496 574

E-mail [a&mc.uk@skf.com](mailto:a&mc.uk@skf.com)

## USA

### SKF Motion Technologies

Tel +1 610 861 4800

Toll free +1 800 541 3624

Fax +1 610 861 3716

E-mail [motiontech.usa@skf.com](mailto:motiontech.usa@skf.com)

## Other countries

Fax +49 972 657 118

E-mail [guidings@skf.com](mailto:guidings@skf.com)

Represented by:

SKF is a registered trademark of the SKF Group.

© SKF Group 2006

The contents of this publication are the copyright of the publisher and may not be reproduced (even extracts) unless prior written permission is granted. Every care has been taken to ensure the accuracy of the information contained in this publication but no liability can be accepted for any loss or damage whether direct, indirect or consequential arising out of the use of the information contained herein.

